



Full color fabric printing made easy.



The Family Thanks You For Putting Your Trust In Us!



Full Color Fabric Printing Made Easy.

Originating in 1994, the *Quinn* family began as flag makers, but today is proud to be the largest provider of full color printed fabric products in the nation. You dream it, we can print it - soft-signage banners, flags, pennants, tents, trade show displays and more - quickly, easily, affordable and on-time.

Want more?

This catalog is just a sampling of our new products and best sellers.
View it all at www.quinnflags.com.



Pricing: Please note that prices can change at any time. Visit www.quinnflags.com for the most up-to-date pricing and terms and conditions.

Prop 65: Quinn has done extensive testing on many of our products, fabrics and inks. Many of our products and most of our fabrics and inks comply with California's Proposition 65, also known as the Safe Drinking Water and Toxic Enforcement Act of 1986. However, due to the nature of our products having hardware, some of them require warning labels at this time. Quinn will continue to test hardware along with other items and as they pass, we will remove them from the list of items that require labeling. Please call us or visit www.quinnflags.com for the most up-to-date Proposition 65 information.



Product Index

New Products and Bestsellers 4

Outdoor and Promotional Flags 6-11

Applied and Embroidered Flags.....	10
Garden Banners.....	10
Golf Flags.....	10
Outdoor Polyester Flags.....	7
Outdoor Polyester Pennants.....	9
Promotional Polyester Flags.....	8
Racing Flags and Sets.....	9
Spinner Flagpoles and Brackets.....	9
Stick Flags.....	11
Vertical Outdoor Polyester Flags.....	8

Table Covers and Runners12-15

Knit Polyester Table Covers.....	15
Knit Polyester Table Runners.....	15
Round Table Covers.....	14
Table Covers.....	13
Table Runners.....	14
Table Top Banners.....	15
Table Toppers.....	14

Portable Banners and Kits16-21

Feather Flags.....	20
Half Drop & Teardrop Banners.....	17-18
Premium Banner Kits.....	18
Swooper Banners.....	19
Windchaser Flag Kits.....	21
Windssocks.....	19

Tents22-24

Heavy Duty Tents.....	24
Standard Tents.....	23
Tent Accessories.....	24

Advertising Banners, Wraps & Covers25-31

Avenue Banners.....	26
Advertising Banners.....	27
Chair Covers.....	31
Giant Flagpole Kits.....	27
Marking and Utility Flags.....	30
Metal Desk Sets.....	30
Mini Teardrop Banners.....	31
Multi-Use Stretch Bands.....	29
Tote Bags (non-woven).....	31
Podium Banners.....	28
Small Item Wraps.....	29
Sunbrella™ Avenue Banners.....	26

Sold exclusively through promotional product distributors and agencies.

* When acceptable artwork is submitted (see website for detail).

** Not available on all products. Additional charges will apply based on quantity, size and requested delivery date.

*** Electronic versions only. Call factory for details.

**** Lead time for Free virtuals is 3-4 days. Rush virtuals are available at an additional cost.

End-user friendly digital catalogs available. Contact factory for details.

School Spirit and Wearables 32-37

Breakaway Banners.....	36
Fan Flags.....	35
Felt Pennants and Banners.....	37
Gonfalons.....	35
School Spirit Flags.....	36
Scroll Banners.....	35
Wearables.....	33-34

Auto Accessories38-39

Car Stretch Products.....	38
Magnetic Car Flags.....	39
Promotional Car Flags.....	39
Traditional Car Flags.....	39

Pennant Strings.....40-41

Pennant Strings.....	41
Stock Pennant Strings.....	41

Display Products42-55

Backpack Flags.....	49
Backdrop Banners.....	43
Booth in a Box.....	54-55
Collaboration Stations.....	45
Custom Display Tables.....	50
Easy A-Frame Kits.....	46
Illuminator Display Kits.....	51
Illuminator InstaStand Kits.....	51
InstaStands.....	50
Mini X-Banner Kits.....	48
Pop-Up Banners.....	49
Retractable Banner Stands.....	46
SlimFit Displays.....	47
Spring Walls.....	45
Stretch Door Runners.....	44
Tower Stands.....	48
Trade Show Packages.....	52-53
Transformer Trunk Kits.....	50
Window Static Clings.....	44
X-Banner Kits.....	48

American Flags & Stock Products56-60

Aluminum Flagpoles.....	59
Historical and Military Flags.....	60
Indoor Sets and Hardware.....	60
Message Flags.....	59
Patriotic American Flag Products.....	59
Pleated Fans.....	57
State and International Flags.....	60
Stick Flags.....	57, 60
U.S. Flags and Home Sets.....	58-59

Quick Ship Products..... 61

Check out these **new** and **bestselling** products from *Quinn!*

From *branding and giveaways* to *displays and signage*, these items are perfect for a variety of markets

Don't forget... custom products include full color digital printing * **AT NO EXTRA COST!**



Canopy Tents
NEW 20' WALLS and ACCESSORIES



Outdoor Flags



Promotional Polyester Flags



Boat Flags



Beach Towels
NEW



Portable Banners



Feather Flags



Windchaser Flags



Avenue Banners



Advertising Banners



Pennant Strings



Marking Flags



Garden Banners

*excludes marking flags and knit beanies



Stick Flags



Car Flags and Accessories



Knit Beanies



Multifunctional Headwear



Felt Pennants



Table Covers and Runners



Table Stands and Counters



Stretch Bands and Covers
NEW CHAIR COVERS



Backdrop Banners



SlimFit Displays



X-Banners



Door Runners



Mini Teardrop Banners



Podium Banners



A-Frame Sandwich Boards



American Flags



Outdoor and Promotional Flags

Put your brand on something that's built to get noticed!

When determining which flag best suits your client's needs...

Where will it be used? – A durable knit polyester is used for long-term outdoor uses and a lighter weight 68D polyester is great for giveaways, indoor use and when a lower price point is needed.

How will it be used/displayed? – Flags can be finished in many ways to accommodate any display (i.e. heading and grommets for flag poles, pole sleeve to display vertically, sewn in rope for extra durability, etc...). Let us know how it will be displayed, and we will suggest the perfect finish!

How should messaging be presented? – A single reverse flag is 1-layer printed on 1 side and bleeds through to the other side creating a mirror image of the design. A double-sided flag is 3-layers that includes 2 prints sewn together with a block-out liner.

What size? – Size is generally determined by the size of the display area and/or price. Our DPP-35 3x5' flag is the most popular best seller! If needed for a flagpole, guidelines are that the length of the flag should be 1/4 to 1/3 the length of the flagpole.

Outdoor Polyester Flags

Markets: Used in Every Market

Uses: Branding, Logo Recognition, Awareness, Attention Getting, Flagpole Display, Indoor Display, Giveaways

Feel the power of branded flags.

Premium Outdoor Polyester Flags



Material: Knit Polyester

Usage: Outdoors

Production time: 7-10 business days

Finish: Fully hemmed on all sides; canvas heading and brass grommets; rope and thimble for flags larger than 6' x 10'; pole sleeve available

Made in USA: Yes

- No Minimum For Premium Flags
- Top Quality & Durability
- Any Shape & Size
- Nylon Flags Available

Single Reverse reads correct on one side & reversed on the backside. Double Sided reads correct on both sides and has a block-out liner in the center.

These flags are finished with heading & grommets.

Single reverse						
Item	Size	1	3	6	12	25
DPP-12	12" x 18"	62.35	58.10	28.65	21.10	13.10
DPP-16	16" x 24"	68.60	64.35	37.40	23.60	15.60
DPP-23	2' x 3'	99.85	73.10	49.85	28.60	23.60
DPP-24	2.5' x 4'	112.35	85.60	62.35	36.10	29.85
DPP-35	3' x 5'	124.35	99.90	73.10	43.60	36.10
DPP-36	3' x 6'	137.10	111.50	85.55	59.98	46.48
DPP-46	4' x 6'	149.85	123.10	98.00	74.35	56.85
DPP-58	5' x 8'	249.35	173.40	149.35	117.75	78.10
DPP-610	6' x 10'	280.00	198.10	168.10	140.00	105.00

Double sided						
Item	Size	1	3	6	12	25
DPP-12D	12" x 18"	78.60	73.10	39.35	27.25	20.60
DPP-16D	16" x 24"	83.60	78.10	48.10	31.00	24.35
DPP-23D	2' x 3'	112.35	90.60	65.10	48.85	39.10
DPP-24D	2.5' x 4'	138.99	115.25	85.99	64.50	54.85
DPP-35D	3' x 5'	165.60	139.90	106.85	80.15	64.20
DPP-36D	3' x 6'	184.35	154.00	122.18	83.30	68.35
DPP-46D	4' x 6'	203.10	168.10	137.50	108.10	86.85
DPP-58D	5' x 8'	300.00	261.55	223.10	182.50	130.60

These flags are finished with rope & thimbles.

Large single reverse flags				
Item	Size	1	3	12
DPP-812	8' x 12'	406.25	286.85	218.75
DPP-1015	10' x 15'	531.25	390.60	286.85
DPP-1218	12' x 18'	622.50	490.60	423.10
DPP-1525	15' x 25'	950.00	743.10	618.75
DPP-2030	20' x 30'	1,256.75	991.45	920.65

Prop 65 WARNING: Cancer and/or Reproductive Harm.
www.P65Warnings.ca.gov. This only applies to the larger flags and hardware listed below.

TOP SELLER!

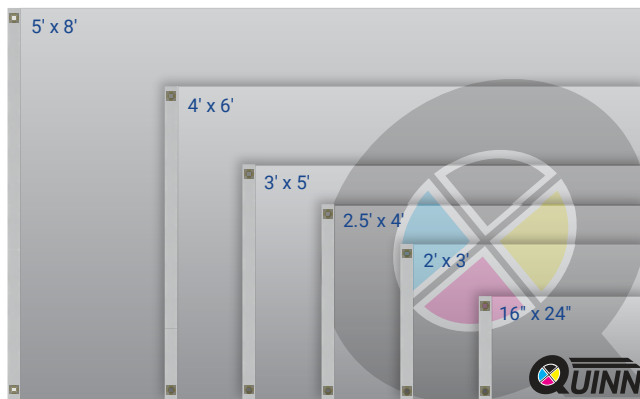

Standard Outdoor Polyester Flags

Material: Knit Polyester

Usage: Outdoors

Production time: 12-15 business days

Finish: Fully hemmed on all sides; canvas heading and brass grommets; pole sleeve available

Made in USA: No



Single reverse						
Item	Size	25	50	100	250	500
DPP-120S	12" x 18"	11.85	8.95	6.45	4.95	3.70
DPP-160S	16" x 24"	14.00	11.25	9.00	6.85	5.40
DPP-230S	2' x 3'	20.05	16.05	12.10	8.50	7.25
DPP-240S	2.5' x 4'	26.85	21.45	16.10	12.05	9.70
DPP-350S	3' x 5'	31.65	25.35	17.75	14.20	13.15
DPP-460S	4' x 6'	48.40	37.85	26.50	21.20	20.10
DPP-580S	5' x 8'	70.40	52.50	44.65	38.25	34.80

Double sided						
Item	Size	25	50	100	250	500
DPP-12DOS	12" x 18"	19.20	16.00	13.65	8.85	7.10
DPP-16DOS	16" x 24"	21.90	20.25	17.20	13.45	11.5
DPP-23DOS	2' x 3'	31.95	28.75	20.05	17.05	14.95
DPP-24DOS	2.5' x 4'	49.35	39.50	29.55	23.75	21.80
DPP-35DOS	3' x 5'	51.80	39.00	35.10	31.60	28.50
DPP-46DOS	4' x 6'	78.15	62.50	53.20	47.95	44.25
DPP-58DOS	5' x 8'	117.50	105.75	95.15	85.50	76.90

Vertical Outdoor Polyester Flags

Markets: Safety, Schools, Sports, Teams, Businesses

Uses: Auditorium Displays, Award Displays, Outdoor Display, Giveaways

Vertical Banners are just like our high quality Outdoor Polyester Flags, except they hang vertically instead of horizontally.

Premium Vertical Outdoor Polyester Flags

Material: Knit Polyester

Usage: Outdoors/ Indoors

Production time: 7-10 business days

Finish: Fully hemmed on all sides; canvas heading and brass grommets; pole sleeve available

Made in USA: Yes



Single Reverse reads correct on one side & reversed on the backside. Double Sided reads correct on both sides and has a block-out liner in the center.

Single reverse						
Item	Size	1	3	6	12	25
DPPB-23	2' x 3'	99.85	73.10	49.85	28.60	23.60
DPPB-24	2.5' x 4'	112.35	85.60	62.35	36.10	29.85
DPPB-35	3' x 5'	124.35	99.90	73.10	43.60	36.10
DPPB-46	4' x 6'	149.85	123.10	98.00	74.35	56.85

Double sided						
Item	Size	1	3	6	12	25
DPPB-23D	2' x 3'	112.35	90.60	65.10	48.85	39.10
DPPB-24D	2.5' x 4'	138.99	115.25	85.99	64.50	54.85
DPPB-35D	3' x 5'	165.60	139.90	106.85	80.15	64.20
DPPB-46D	4' x 6'	203.10	168.10	137.50	108.10	86.85

Standard Vertical Outdoor Polyester Flags

Material: Knit Polyester

Usage: Outdoors

Production time: 12-15 business days

Finish: Fully hemmed on all sides; canvas heading and brass grommets; pole sleeve available

Made in USA: No

Single reverse						
Item	Size	25	50	100	250	500
DPPB-12OS	12" x 18"	11.85	8.95	6.45	4.95	3.70
DPPB-16OS	16" x 24"	14.00	11.25	9.00	6.85	5.40
DPPB-23OS	2' x 3'	20.05	16.05	12.10	8.50	7.25
DPPB-24OS	2.5' x 4'	26.85	21.45	16.10	12.05	9.70
DPPB-35OS	3' x 5'	31.65	25.35	17.75	14.20	13.15
DPPB-46OS	4' x 6'	48.40	37.85	26.50	21.20	20.10

Double sided						
Item	Size	25	50	100	250	500
DPPB-23DOS	2' x 3'	31.95	28.75	20.05	17.05	14.95
DPPB-24DOS	2.5' x 4'	49.35	39.50	29.55	23.75	21.80
DPPB-35DOS	3' x 5'	51.80	39.00	35.10	31.60	28.50
DPPB-46DOS	4' x 6'	78.15	62.50	53.20	47.95	44.25

Outdoor Polyester Pennants

Markets: Boats, Marinas

Uses: Events, Giveaways, Boat Display

Pennant shaped flags are most popular for their use at marinas and on boats, but their eye-catching shape is sure to attract attention anywhere.

Material: Knit Polyester

Usage: Outdoors

Production time: 7-10 business days

Finish: Fully hemmed on all sides; canvas heading and brass grommets; pole sleeve available

Made in USA: Yes



Single Reverse reads correct on one side & reversed on the backside. Double Sided reads correct on both sides and has a block-out liner in the center.

Single reverse						
Item	Size	1	3	6	12	25
DPP-12TRIS	12" x 18"	65.20	60.75	29.95	22.05	13.75
DPP-16TRIS	16" x 24"	71.65	67.25	39.05	24.65	16.30
DPP-23TRIS	2' x 3'	104.30	76.40	52.10	29.90	24.65
DPP-24TRIS	2.5' x 4'	112.35	85.60	62.35	36.10	29.85
DPP-35TRIS	3' x 5'	129.95	104.40	76.40	45.55	37.75
DPP-46TRIS	4' x 6'	149.85	123.10	98.00	74.35	56.85
DPP-58TRIS	5' x 8'	249.35	173.40	149.35	117.75	78.10

Double sided						
Item	Size	1	3	6	12	25
DPP-12TRID	12" x 18"	86.46	80.41	43.29	29.98	22.66
DPP-16TRID	16" x 24"	91.96	85.91	52.91	34.10	26.79
DPP-23TRID	2' x 3'	123.59	99.66	71.61	53.74	42.99
DPP-24TRID	2.5' x 4'	138.99	115.25	85.99	48.60	41.75
DPP-35TRID	3' x 5'	182.16	153.89	117.54	88.17	70.62
DPP-46TRID	4' x 6'	203.10	168.10	137.50	108.10	86.85
DPP-58TRID	5' x 8'	300.00	261.55	223.10	182.50	130.60

Promotional Polyester Flags



Markets: Event Marketing , Sports Teams, Schools

Uses: Events, Giveaways, Promotions

These single reverse flags are great for giveaways, advertising campaigns and events.

Material: 100D Polyester

Usage: Indoors

Production time: 10-15 business days

Finish: Fully hemmed on all sides; canvas heading and brass grommets; pole sleeve available

Made in USA: No

Horizontal						
Item	Size	50	100	250	500	1,000
DPP-68-23	2' x 3'	13.25	10.15	8.15	6.54	5.85
DPP-68-24	2.5' x 4'	19.20	13.55	11.55	9.75	8.25
DPP-68-35	3' x 5'	21.55	16.34	13.90	12.90	11.60
DPP-68-46	4' x 6'	30.25	23.60	21.25	19.10	17.25

Vertical						
Item	Size	50	100	250	500	1,000
DPPB-68-23	2' x 3'	13.25	10.15	8.15	6.54	5.85
DPPB-68-24	2.5' x 4'	19.20	13.55	11.55	9.75	8.25
DPPB-68-35	3' x 5'	21.55	16.34	13.90	12.90	11.60

Aluminum Spinner Pole with Ball Top

Our revolutionary pole keeps your flag from wrapping around the pole. Featuring a top section that spins freely, allowing the flag to stay unwrapped. The 1" diameter pole includes a simple ball top and 2 clear EZ-Mount (TM) rings. The 6' pole will only work with flags 3' x 5' or smaller.

Item	Size	Color	1	12
SP-205	6'	Silver	21.25	20.10
SP-305	6'	White	22.75	20.40

Adjustable Aluminum Bracket

Display your logo to gain maximum visibility with the help of this adjustable aluminum bracket! Features an adjustable angle and comes with a convenient thumb screw. Designed for flagpoles 1" in diameter, great for areas space may be limited.

Item	Color	1	48
SLB-110	Silver	12.64	10.80
SLB-115	White	12.64	10.80



Prop 65 WARNING: Cancer and/or Reproductive Harm. www.P65Warnings.ca.gov

Racing Flags and Sets

Markets: Racing Events, Fundraisers, Tournaments

Uses: Communicating, Signage Display, Giveaways, Sponsorships

Ideal for communicating with drivers during any exciting car race or as a gift for any racing fan. Perfect way to make a lasting impression!

Material: Polyethylene

Usage: Outdoors

Production time: 3-5 Business Days

Finish: Leads on both ends

Made in USA: Yes

Prop 65 WARNING: Cancer and/or Reproductive Harm. www.P65Warnings.ca.gov

Black and white checkered pennant strings				
Item	Length	2	25	50
CTS-30	30'	10.33	8.53	7.93
CTS-60	60'	16.30	15.76	15.43
CTS-100	100'	26.63	25.22	24.95



Material: Knit Polyester

Usage: Outdoors

Production time: 7-10 Business Days

Finish: Pole sleeve

Made in USA: Yes

Prop 65 WARNING: Cancer and/or Reproductive Harm. www.P65Warnings.ca.gov (items with wood staff)



Custom race flags available upon request. Contact us for details.

Individual racing flags						
Item	Size	Type of flag	Finish	6	12	25
IRU-210	24" x 30"	Yellow Caution	Pole sleeve only	46.52	25.27	20.27
IRM-110	24" x 30"	Yellow Caution	Wood staff incl.	49.85	28.60	23.60
IRU-215	24" x 30"	Black Leave track	Pole sleeve only	46.52	25.27	20.27
IRM-115	24" x 30"	Black Leave track	Wood staff incl.	49.85	28.60	23.60
IRU-230	24" x 30"	White One Lap to Finish	Pole sleeve only	46.52	25.27	20.27
IRM-130	24" x 30"	White One Lap to Finish	Wood staff incl.	49.85	28.60	23.60
IRU-205	24" x 30"	Green Start Race	Pole sleeve only	46.52	25.27	20.27
IRM-105	24" x 30"	Green Start Race	Wood staff incl.	49.85	28.60	23.60
IRU-220	24" x 30"	Red Stop Flag	Pole sleeve only	46.52	25.27	20.27
IRM-120	24" x 30"	Red Stop Flag	Wood staff incl.	49.85	28.60	23.60
IRU-225	24" x 30"	Blue Move to Outside	Pole sleeve only	46.52	25.27	20.27
IRM-125	24" x 30"	Blue Move to Outside	Wood staff incl.	49.85	28.60	23.60
IRU-235	24" x 30"	Checkered End of Race	Pole sleeve only	46.52	25.27	20.27
IRM-135	24" x 30"	Checkered End of Race	Wood staff incl.	49.85	28.60	23.60

Racing flag set (includes all 7 flags)					
Item	Size	Finish	6	12	25
ARM-2430	24" x 30"	Wood staff included	350.00	200.00	165.00

Garden Banners



Markets: Teams, Schools, Homes, Political, Businesses

Uses: Spirit, Awareness, Advertising

Best quality and customizable garden banners will create a striking display in a wide variety of public areas.

Material: Knit Polyester
Usage: Outdoors
Production time: 7-10 business days
Finish: Fabric pole sleeve
Made in USA: Yes
Prop 65 WARNING: Cancer and/or Reproductive Harm. www.P65Warnings.ca.gov



Single Reverse reads correct on one side & reversed on the backside.
 Double Sided reads correct on both sides and has a block-out liner in the center.

Kits with banner and hardware							
Item	Size	Sides	1	3	6	12	25
GB-1218K	12" x 18"	Single Reverse	74.15	70.00	35.00	31.65	22.05
GB-1218DK	12" x 18"	Double Sided	90.80	85.00	50.80	37.50	29.15
GB-1420K	13.75" x 20"	Single Reverse	76.65	71.65	42.05	33.30	23.75
GB-1420DK	13.75" x 20"	Double Sided	92.50	87.05	52.50	39.17	31.67

Replacement banners							
Item	Size	Sides	1	3	6	12	25
GB-1218	12" x 18"	Single Reverse	62.40	58.15	28.70	21.15	13.15
GB-1218D	12" x 18"	Double Sided	78.65	73.15	39.40	27.25	20.65
GB-1420	13.75" x 20"	Single Reverse	64.40	60.15	30.70	23.15	15.15
GB-1420D	13.75" x 20"	Double Sided	80.65	75.15	41.40	29.25	22.65

*hardware imported

Golf Flags



Markets: Golf, Fundraisers

Uses: Events, Tournaments, Sponsorships

Score a hole in one at your next event with golf flags. Great for giveaways at golf courses & tournaments! Nylon material available upon request.

Material: Knit Polyester
Usage: Outdoors
Production time: 7-10 business days
Finish: Fully hemmed on all sides; canvas heading and brass grommets or sewn in golf tube
Made in USA: Yes
Prop 65 WARNING: Cancer and/or Reproductive Harm. www.P65Warnings.ca.gov



Single Reverse reads correct on one side & reversed on the backside.
 Double Sided reads correct on both sides and has a block-out liner in the center.

Single reverse							
Item	Size	Finish	1	3	6	12	25
GFGS-1420	14" x 20"	Heading & grommets	80.85	54.90	31.90	19.90	12.45
GFTS-1420	14" x 20"	Golf Tube	83.15	57.40	41.90	27.40	19.70

Double sided							
Item	Size	Finish	1	3	6	12	25
GFGD-1420	14" x 20"	Heading & grommets	86.90	61.15	37.40	30.85	27.50
GFTD-1420	14" x 20"	Golf Tube	98.15	64.40	49.00	44.15	35.85

Available Finishes



3/4" Golf Tube
 (Fits standard 3/4" diameter golf pole)



Heading & Grommets

Appliquéd and Embroidered Flags

When small quantities of a custom flag are required and the design is relatively simple, the appliqué or embroidery process may be the perfect choice. Both are durable and showcase your design in the best possible way. The complexity of the artwork determines the price and availability since appliqué flags are cut and sewn by hand, while embroidered flags are digitized and finished by hand. Unlike digitally printed flags, appliqué and embroidered flags cannot show any gradients or shading, only spot colors.



Appliquéd



Embroidered

Embroidered Golf Flags Also Available!

Stick Flags

Markets: Sports, Awareness, Collegiate, Businesses

Uses: Desk Sets, Parades, Giveaways, Markers, Handheld

Increase audience participation by passing these out at speeches, rallies, holiday parties and much more.

Material: Polyester
Usage: Outdoors / Indoors
Production time: 7-10 business days
Finish: Heat cut edges / 8 x 12" and larger or double sided are finished with hemmed edges
Made in USA: No
Prop 65 WARNING: Cancer and/or Reproductive Harm.
www.P65Warnings.ca.gov

Single Reverse reads correct on one side & reversed on the backside. Double Sided reads correct on both sides and has a block-out liner in the center.



Example: Polyester flag is flexible and will hang down the staff when held upright

Single reverse						
Item	Size	25	50	100	250	500
DPSF-461001	4" x 6"	8.40	5.70	4.15	2.68	1.88
DPSF-691001	6" x 9"	9.60	5.88	4.45	3.05	2.02
DPSF-8121001	8" x 12"	9.98	7.35	4.90	3.55	2.75
DPSF-12181001	12" x 18"	13.25	7.95	6.80	4.75	3.60
DPSF-16241001	16" x 24"	15.25	11.40	9.20	7.55	6.30

Double sided						
Item	Size	25	50	100	250	500
DPSF-461002	4" x 6"	10.20	6.10	4.90	3.40	2.48
DPSF-691002	6" x 9"	11.15	7.45	6.45	4.45	3.45

Bases available



*bases not for use with these sizes

Stick Flags with Plastic Liner

Want your flags to remain upright?! We have the perfect solution for you. These stick flags with plastic liners will make sure your brand stands out always!



Solid White Liner

Double sided						
Item	Size	100	250	500	1000	2500
DPSF-46DL	4x6	5.95	4.35	3.45	2.95	2.80

Stick Flags Sets

Show off your brand with this desktop decoration! Combined with our new weighted base gives customers just what they've been asking for!

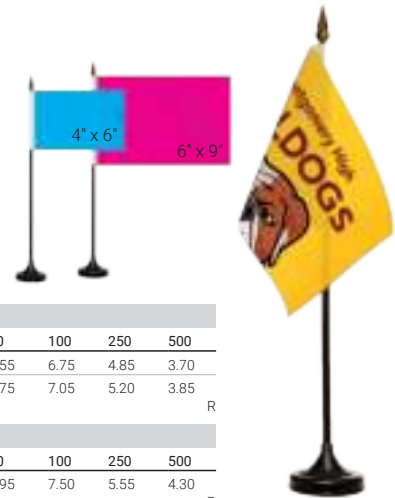

Single reverse						
Item	Size	25	50	100	250	500
DPSF-461GWB	4" x 6"	11.65	8.55	6.75	4.85	3.70
DPSF-691GWB	6" x 9"	12.85	8.75	7.05	5.20	3.85

Double sided						
Item	Size	25	50	100	250	500
DPSF-462GWB	4" x 6"	13.45	8.95	7.50	5.55	4.30

U.S. Imprinted 10" Wooden Staff

Show some patriotism with the 4" x 6" U.S. cotton flag on an imprinted 10" wooden staff! Customize with a personal message, corporate slogan, or company name on the convenient wooden stick.

Item	Size	1000	2500	5000
ECS-46P	4" x 6"	1.35	1.15	1.05

Stick Flags with Imprinted Wooden Staffs

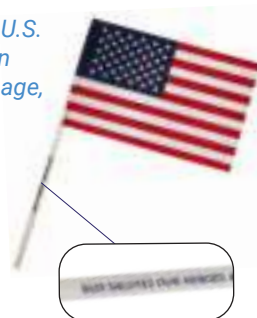

Custom Imprinted Wooden Staff

Customize with any art! It's made using polyester materials and features heat cut edges a pole sleeve and a 10" natural wooden staff capable of supporting 36 characters.

Item	Size	1000	2500	5000	10000
DPSF-CUSTOMP	4" x 6"	1.95	1.37	1.15	1.10





Photograph by Normand Huberdeau

Table Covers and Runners

Have the most professional table top display with full color graphics and top-quality fabrics!

When determining which Table Cover or Runner best suits your client's needs...

Where will it be used? – Stretch and fitted table covers are ideal for outdoor use since wind will not impact the display as they would with throws and runners.

How will it be used/displayed? – Different finish options are available if storing objects under the table, such as an open back 3-sided option or sewn in zipper for easier access, and a convertible table cover can fit 6' and 8' tables.

How should messaging be presented? – Full color printing anywhere on the table cover or runner provides optimal messaging. **Our unique easy to use pricing makes our table covers easy to sell since price is the same regardless of art, material and finish for each size!**

What size? – It is important to know not only the length of the table but also the width. Standard widths for 6' and 8' tables are 30" width for 4', 6' and 8' tables.

Pay One Low Price Regardless of Style, Finish or Artwork*



Throw Table Covers

TRADITIONAL BEST SELLER!



Full Back (DTC)



Open Back (DTCOB)

Markets: Financial, Trade Show, Events

Uses: Branding, Awareness, Advertising, Special Occasions

Ideal for a wide variety of events and occasions. Custom sizes also available.

Material: Premium Polyester
Usage: Indoors / Short-term Outdoors
Production time: 7-10 business days
Finish: Fully hemmed on all sides
Made in USA: Yes

Throw							
Item	Size	Finish	1	3	6	12	25
DTC-4F / DTCOB-4	4'	Full / Open	245.00	220.50	187.50	160.00	128.00
DTC-6F / DTCOB-6	6'	Full / Open	255.00	230.00	200.50	175.00	140.00
DTC-8F / DTCOB-8	8'	Full / Open	275.00	250.00	220.00	190.00	152.00

R

Fitted Table Covers



Full Back (DTCF)



Open Back (DTCFOB)



Zipper Back (DTCFZ)

Material: Premium Polyester
Usage: Indoors / Short-term Outdoors
Production time: 7-10 business days
Finish: Fully hemmed on all sides
Made in USA: Yes
Prop 65 WARNING: Cancer and/or Reproductive Harm.
www.P65Warnings.ca.gov (zipper only / item DTCFZ)

Fitted							
Item	Size	Finish	1	3	6	12	25
DTCF-4 / DTCFOB-4 / DTCFZ-4	4'	Full / Open / Zipper	245.00	220.50	187.50	160.00	128.00
DTCF-6 / DTCFOB-6 / DTCFZ-6	6'	Full / Open / Zipper	255.00	230.00	200.50	175.00	140.00
DTCF-8 / DTCFOB-8 / DTCFZ-8	8'	Full / Open / Zipper	275.00	250.00	220.00	190.00	152.00

R

Stretch Table Covers



Full Back (DTCS)



Open Back (DTCSOB)



Zipper Back (DTCSZ)

Material: Stretch Polyester
Usage: Indoors / Short-term Outdoors
Production time: 7-10 business days
Finish: Fully hemmed on all sides
Made in USA: Yes
Prop 65 WARNING: Cancer and/or Reproductive Harm.
www.P65Warnings.ca.gov (zipper only / item DTCSZ)

Stretch							
Item	Size	Finish	1	3	6	12	25
DTCS-4 / DTCSOB-4 / DTCSZ-4	4'	Full / Open / Zipper	245.00	220.50	187.50	160.00	128.00
DTCS-6 / DTCSOB-6 / DTCSZ-6	6'	Full / Open / Zipper	255.00	230.00	200.50	175.00	140.00
DTCS-8 / DTCSOB-8 / DTCSZ-8	8'	Full / Open / Zipper	275.00	250.00	220.00	190.00	152.00

R



Convenient clear zippered plastic bag included with every table cover**

*price varies by size only
 **bag included only for quantities up to 25

Table Runners



Ideal for a wide variety of events and occasions. Custom sizes are also available.

Material: Premium Polyester
 Usage: Indoors / Short-term Outdoors
 Production time: 7-10 business days
 Finish: Fully hemmed on all sides
 Made in USA: Yes



Item	Size	1	3	6	12	25
DTCR-3060	30" x 60"	103.15	81.25	73.15	57.40	49.50
DTCR-3072	30" x 72"	124.40	103.15	85.65	69.90	58.50
DTCR-3084	30" x 84"	143.75	120.25	101.75	82.40	69.75
DTCR-3090	30" x 90"	155.00	128.15	106.25	88.65	75.50
DTCR-6060	60" x 60"	195.00	165.00	137.50	116.15	100.65
DTCR-6072	60" x 72"	233.15	193.15	165.00	136.15	118.00
DTCR-6090	60" x 90"	292.50	242.75	199.90	165.65	147.50

R

Round Table Covers



Fitted

Throw

Stretch

Solid Colors are also available!

Demand attention and draw crowds to your table at conventions, conferences and trade shows.

Material: Premium Polyester / Stretch Polyester
 Usage: Indoors / Short-term Outdoors
 Production time: 7-10 business days
 Finish: Fully hemmed on all sides
 Made in USA: Yes

Throw						
Item	Diameter	1	5	10	25	50
DTC-30R	30"	264.00	134.00	101.00	75.00	64.00

R

Stretch						
Item	Size	1	3	6	13	25
DTCS-23R	23.6" x 29.1"	216.00	125.65	106.50	78.25	60.95
DTCS-30R	31.9" x 29.1"	226.00	128.45	109.30	79.25	62.65
DTCS-31R	31.9" x 43.3"	256.00	149.85	112.35	92.40	74.85
DTCS-37R	37.4" x 28.7"	248.00	138.60	108.70	86.35	66.90

R

Fitted						
Item	Size	1	3	6	13	25
DTCF-23R	23.6" x 29.1"	226.00	125.65	109.30	79.25	62.65
DTCF-31R	31.9" x 43.3"	256.00	149.85	112.35	86.40	74.85
DTCF-37R	37.4" x 28.7"	248.00	138.60	108.70	86.35	66.90

R

Price Includes Full Color Anywhere on the Cover

Table Toppers



Perfect for giving a professional touch to any presentation, company picnic, trade show or fundraiser.

Material: Polyester
 Usage: Indoors / Short-term Outdoors
 Production time: 7-10 business days
 Finish: Fully hemmed on all sides
 Made in USA: Yes



Item	Size	1	3	6	13	25
DTCTTS-4	4'	191.20	96.70	77.65	58.30	44.10
DTCTTS-6	6'	205.00	118.10	92.70	68.20	54.25
DTCTTS-8	8'	228.00	138.60	106.05	83.55	69.45

R

Knit Polyester Table Covers and Runners

An economical alternative to our premium polyester covers and runners featuring high quantities for lower prices.



Cover



Runner

Material: Knit Polyester
Usage: Indoors / Short-term Outdoors
Production time: 7-10 business days
Finish: Sewn around the edges
Made in USA: No

Knit polyester table covers						
Item	Size	25	50	100	250	500
DTC-4FKP	4'	93.10	84.80	78.25	70.35	65.40
DTC-6FKP	6'	111.00	101.95	97.70	84.70	78.45
DTC-8FKP	8'	129.75	120.10	112.50	99.65	92.45

R

Knit polyester table runners						
Item	Size	25	50	100	250	500
DTCR-3060KP	30' x 60"	29.90	24.25	20.15	16.55	14.90
DTCR-3072KP	30' x 72"	35.10	28.45	22.15	19.10	17.20
DTCR-3084KP	30' x 84"	39.70	32.65	25.40	21.95	19.75
DTCR-6060KP	60' x 60"	53.70	43.70	35.05	30.10	27.30
DTCR-6072KP	60' x 72"	61.75	48.30	40.50	35.00	31.90

R

Table Top Banners

Two-Sided Banner Can Have Different Imprints

Markets: Trade Shows, POP, Education, Organizations, Safety

Uses: Seminars, Advertising, Branding

Sleek. Easy. Versatile. Lightweight. These aluminum tube-frame banners are a must for anyone in need of a professional looking backdrop that takes seconds to set up.

Material: Stretch Polyester
Usage: Indoors
Production time: 7-10 business days
Finish: Sewn around the edges
Made in USA: Yes
Prop 65 WARNING: Cancer and/or Reproductive Harm. www.P65Warnings.ca.gov



Table Top Banner Kit



Sign Up Table Kit



Table Cover Half Wall Kit



Table Cover Full Wall Kit

Table top banner kit with hardware						
Item	Size	1	3	6	12	25
TTVB-2006T1K	6' / Small	247.84	200.92	196.33	130.46	117.08
TTVB-2008T1K	8' / Small	261.23	211.78	159.93	137.50	123.40
TTVB-2006T2K	6' / Medium	296.93	272.82	190.46	177.14	153.52
TTVB-2008T2K	8' / Medium	346.84	240.66	213.42	192.55	177.35
TTVB-2006T3K	6' / Large	361.20	250.63	222.26	200.53	184.69
TTVB-2008T3K	8' / Large	416.71	328.16	282.15	253.21	239.99

R

Table top replacement banners						
Item	Size	1	3	6	12	25
TTVB-2006T1R	6' / Small	104.41	87.02	76.78	70.55	49.25
TTVB-2008T1R	8' / Small	120.47	100.41	81.41	61.47	54.52
TTVB-2006T2R	6' / Medium	210.81	155.03	107.57	99.44	86.07
TTVB-2008T2R	8' / Medium	232.28	188.31	142.20	122.27	109.73
TTVB-2006T3R	6' / Large	248.56	201.51	152.17	130.84	117.42
TTVB-2008T3R	8' / Large	375.21	229.70	203.71	183.79	171.16

R

Sign-up table kit (stretch polyester table cover included)						
Item	Size	1	3	6	12	25
SUT-6K	6'	502.84	430.92	396.83	305.46	242.08
SUT-8K	8'	536.23	461.78	379.93	327.50	258.40

R

Table cover half wall kit (stretch polyester table cover included)						
Item	Size	1	3	6	12	25
TCHW-6K	6'	551.93	502.82	390.96	352.14	278.52
TCHW-8K	8'	621.84	490.66	433.42	382.55	312.35

R

Table cover full wall kit (stretch polyester table cover included)						
Item	Size	1	3	6	12	25
TCFW-6K	6'	616.20	480.63	422.76	375.53	309.69
TCFW-8K	8'	747.94	578.16	502.15	443.21	374.99

R

*hardware imported



Portable Banners and Kits

***Get maximum brand exposure and messaging
at any location or event!***

When determining which Portable Banner best suits your client's needs...

Where will it be used? – Environmental conditions and possible vandalism dramatically impact longevity. Outdoor displays should be brought in during severe weather conditions and never left displayed overnight.

How will it be used/displayed? – If displayed on a hard surface, a cross base will be necessary. If going into the ground, a ground spike can be used. We have easy to use options for any use.

How should messaging be presented? – A single reverse message reads correctly on one side with the mirror image on back. Double-sided reads correctly on both sides but cost is higher.

What size? – The larger the size, the greater the impact but also the cost. Indoor, make sure full display is not taller than ceiling height.

Portable Half Drop and Teardrop Banner Kits



Markets: Sports, Schools, Real Estate, Trade Shows, Businesses, Restaurants

Uses: Events, Conferences, Seminars, Fairs, Festivals, Roadside Display, Indoor Display, Branding, Advertising

Give your brand or your next outdoor event the exposure it needs with our eye-catching Portable Banners!

Material: Knit Polyester
 Usage: Outdoors / Indoors
 Production time: 7-10 business days
 Finish: Black nylon pole sleeve
 Made in USA: Yes
 Prop 65 WARNING:
 Cancer and/or Reproductive Harm.
 www.P65Warnings.ca.gov



Teardrop

Half Drop

- Attention Grabber
- Portable and Lightweight
- Easy 5 Minute Assembly
- Indoor and Outdoor Use

Single Reverse reads correct on one side and reversed on the backside.
 Double Sided reads correct on both sides and has a block-out liner in the center.

For surfaces where a spike can be inserted into the ground only.

Kits with banner, hardware with ground spike and carrying case							
Item	Size	Sides	1	3	6	12	25
PTB-6K / PHB-6K	6'	Single Reverse	177.95	165.45	152.95	125.45	103.70
PTB-8K / PHB-8K	8'	Single Reverse	192.95	179.85	166.70	136.70	112.45
PTB-10K / PHB-10K	10'	Single Reverse	210.45	201.70	192.95	166.10	138.10
PTB-12K / PHB-12K	12'	Single Reverse	222.95	217.95	212.95	178.45	150.45
PTB-15K / PHB-15K	15'	Single Reverse	253.45	245.35	237.20	198.70	166.20
PTB-D6K / PHB-D6K	6'	Double Sided	243.60	223.25	202.95	174.85	150.60
PTB-D8K / PHB-D8K	8'	Double Sided	268.60	251.40	234.20	202.00	173.70

R

For surfaces where a spike can be inserted into the ground or hard surface for the cross base.

Kits with banner, hardware with ground spike, cross base and carrying case							
Item	Size	Sides	1	3	6	12	25
PTB-6KC / PHB-6KC	6'	Single Reverse	206.05	193.55	181.05	151.05	125.55
PTB-8KC / PHB-8KC	8'	Single Reverse	221.05	207.95	194.80	162.30	134.30
PTB-10KC / PHB-10KC	10'	Single Reverse	238.55	229.80	221.05	191.70	159.95
PTB-12KC / PHB-12KC	12'	Single Reverse	251.05	246.05	241.05	204.05	172.30
PTB-15KC / PHB-15KC	15'	Single Reverse	281.55	273.45	265.30	224.30	188.05
PTB-D6KC / PHB-D6KC	6'	Double Sided	271.70	251.35	231.05	200.45	172.45
PTB-D8KC / PHB-D8KC	8'	Double Sided	296.70	279.50	262.30	227.60	195.55

R

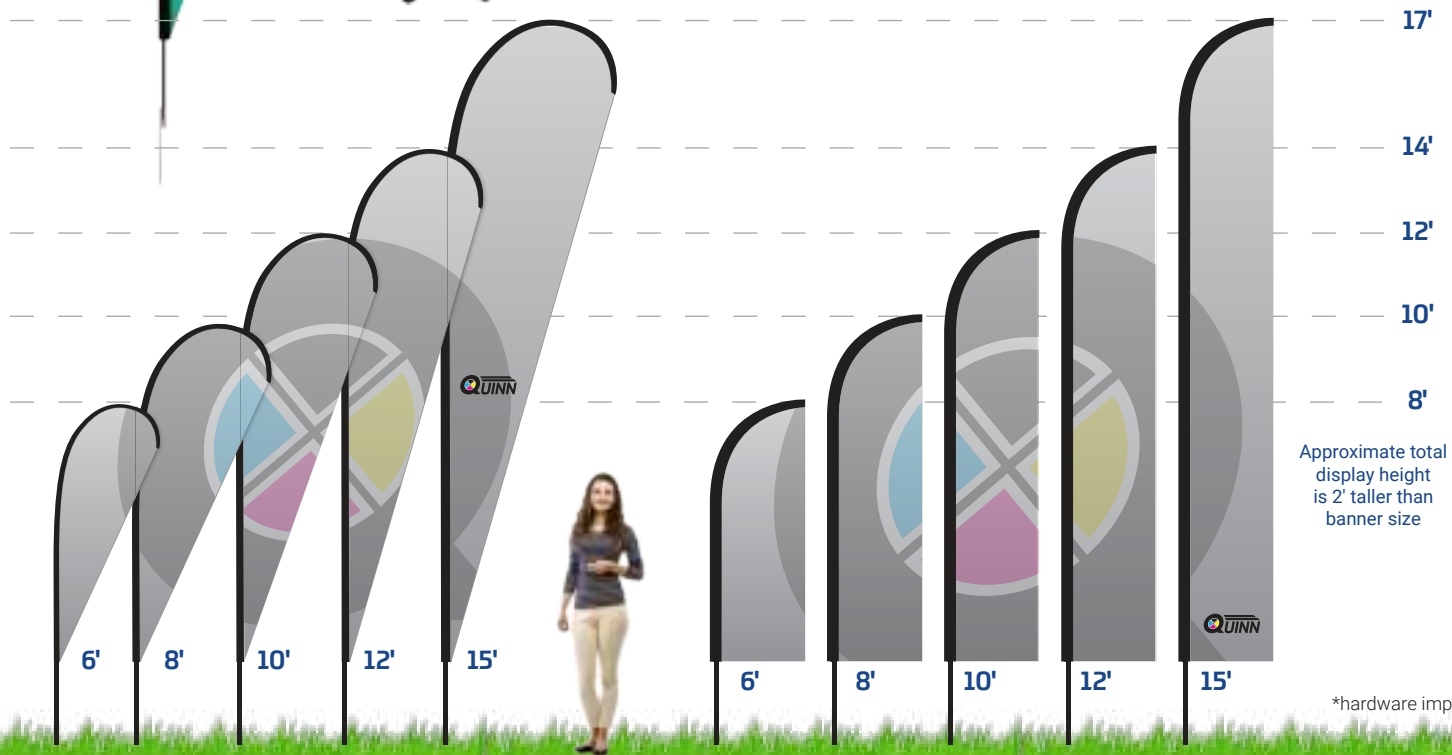

*hardware imported

Replacement Portable Half Drop and Teardrop Banners

Material: Knit Polyester
 Usage: Outdoors
 Production time: 7-10 business days
 Finish: Black nylon pole sleeve
 Made in USA: Yes
 Prop 65 WARNING: Cancer and/or Reproductive Harm. www.P65Warnings.ca.gov



Single Reverse reads correct on one side and reversed on the backside. Double Sided reads correct on both sides and has a block-out liner in the center.

Single reverse						
Item	Size	1	3	6	12	25
PTB-6 / PHB-6	6'	115.60	103.10	90.60	65.60	46.85
PTB-8 / PHB-8	8'	124.35	111.25	98.10	70.60	49.35
PTB-10 / PHB-10	10'	135.60	126.85	118.10	93.75	68.75
PTB-12 / PHB-12	12'	140.60	135.60	130.60	98.60	73.60
PTB-15 / PHB-15	15'	162.35	154.25	146.10	110.10	80.60

Double sided						
Item	Size	1	3	6	12	25
PTB-D6 / PHB-D6	6'	181.25	160.90	140.60	115.00	93.75
PTB-D8 / PHB-D8	8'	200.00	182.80	165.60	135.90	110.60
PTB-D10 / PHB-D10	10'	218.10	207.80	197.50	159.35	130.00
PTB-D12 / PHB-D12	12'	262.50	243.75	225.00	194.35	158.40
PTB-D15 / PHB-D15	15'	290.60	271.80	253.00	224.85	190.60

Hardware for Portable Banners

Hardware includes a sectional aluminum and fiberglass pole, ground spike and carrying bag.

Item	Size	1	12	25
PTH-6H / PTH-6T	6'	62.35	59.85	56.85
PTH-8H / PTH-8T	8'	68.60	66.10	63.10
PTH-10H / PTH-10T	10'	74.85	72.35	69.35
PTH-12H / PTH-12T	12'	82.35	79.85	76.85
PTH-15H / PTH-15T	15'	91.10	88.60	85.60

Additional Portable Options for Half Drop & Teardrop Banners



Premium Banner Kits

Material: Knit Polyester
 Usage: Outdoors
 Production time: 7-10 business days
 Finish: Fabric pole sleeve with a sewn in loop at bottom of pole sleeve
 Made in USA: Yes
 Prop 65 WARNING: Cancer and/or Reproductive Harm. www.P65Warnings.ca.gov



For surfaces where a spike can be inserted into the ground only.

Kits with banner, premium hardware and ground spike							
Item	Size	Sides	1	3	6	12	25
PHB-D10P / PTB-D10P	10'	Double Sided	342.60	332.30	311.30	263.80	228.65
PHB-D12P / PTB-D12P	12'	Double Sided	387.00	368.25	338.80	298.80	257.05
PHB-D15P / PTB-D15P	15'	Double Sided	415.10	396.30	366.80	329.30	289.25

For surfaces where a spike can be inserted into the ground or hard surface for the cross base.

Kits with banner, premium hardware and cross base with removable ground spike							
Item	Size	Sides	1	3	6	12	25
PHB-D10PC / PTB-D10PC	10'	Double Sided	375.60	365.30	338.95	292.20	251.65
PHB-D12PC / PTB-D12PC	12'	Double Sided	420.00	401.25	366.45	327.20	280.05
PHB-D15PC / PTB-D15PC	15'	Double Sided	448.10	429.30	394.45	357.70	312.25



*hardware imported

TOP SELLER!



Markets: Auto Dealerships, Sports, Schools, Real Estate, Businesses, Restaurants

Uses: Events, Conferences, Seminars, Fairs, Festivals, Roadside Display, Branding, Advertising

Go with reliable outdoor advertising that's made to get noticed. Single reverse swooper banners are 12' tall and stand 15' tall with hardware.

Material: Knit Polyester
Usage: Outdoors
Production time: 7-10 business days
Finish: Black nylon pole sleeve
Made in USA: Yes
Prop 65 WARNING: Cancer and/or Reproductive Harm. www.P65Warnings.ca.gov



Kits with banner and hardware				
Item	Size	1	12	25
SWOOP-C12K	12' Banner, 15' Hardware	134.55	128.25	120.15

Replacement banners and hardware				
Item	Product	1	12	25
SWOOP-C12	Banner	62.15	59.75	55.50
SWOOP-15FS	Hardware	72.40	68.50	64.65

- **Stationary & Sets up in Minutes**
- **Economical Alternative to our Feather Flag**

*hardware imported

Windsocks



Markets: Safety, Aviation, Organizations

Uses: Branding, Airports, Highways, Seaports

Let your customers get wind of your brand with a custom imprinted windsock! This cool outdoor accessory is made using printed knit polyester for a high flying promotional display that you can count on.

Material: Knit Polyester
Usage: Outdoors
Production time: 10 business days
Finish: Reinforced grommets around the large opening
Made in USA: No

Item	Size	1	3	6	12	25
WIND-6X24	6" x 24"	145.00	92.50	60.15	35.95	22.85
WIND-8X36	8" x 36"	150.35	96.50	62.75	43.45	31.20
WIND-10X36	10" x 36"	151.90	97.50	63.40	49.40	35.20
WIND-18X48	18" x 48"	178.00	119.50	77.70	70.65	47.45
WIND-18X60	18" x 60"	185.00	126.50	82.25	75.35	55.95
WIND-18X72	18" x 72"	210.00	182.50	118.65	83.90	60.50
WIND-18X96	18" x 96"	225.00	210.50	136.85	93.25	72.90
WIND-24X72	24" x 72"	225.00	210.50	136.85	93.25	72.90
WIND-24X96	24" x 96"	240.00	219.50	142.70	118.90	98.25
WIND-36X120	36" x 120"	350.00	298.50	194.15	169.90	142.50

Feather Flags



Square Style: S

Flutter Style: L

Feather Style: E

**3 Different Cuts.
All Same Price!
One Cut Per Design**

Our unique shape and tall design Feather Flags are sure to grab attention. Three different eye-catching cuts all at the same price!

Material: Knit Polyester
Usage: Outdoors
Production time: 7-10 business days
Finish: Fabric pole sleeve with a sewn in loop at bottom of pole sleeve
Made in USA: Yes
Prop 65 WARNING: Cancer and/or Reproductive Harm.
www.P65Warnings.ca.gov



Insert the style of your desired cut in place of the underscore in the item number. See style designations below.

Single Reverse reads correct on one side and reversed on the backside. See website for double sided options.

Single reverse						
Item	Size	1	6	12	25	50
FFK-_-38	3' x 8'	124.35	111.25	98.10	70.60	49.35
FFK-_-310	3' x 10'	149.85	126.85	118.10	93.75	68.75
FFK-_-312	3' x 12'	172.30	135.60	130.60	98.60	73.60
FFK-_-315	3' x 15'	198.15	154.25	146.10	110.10	80.60

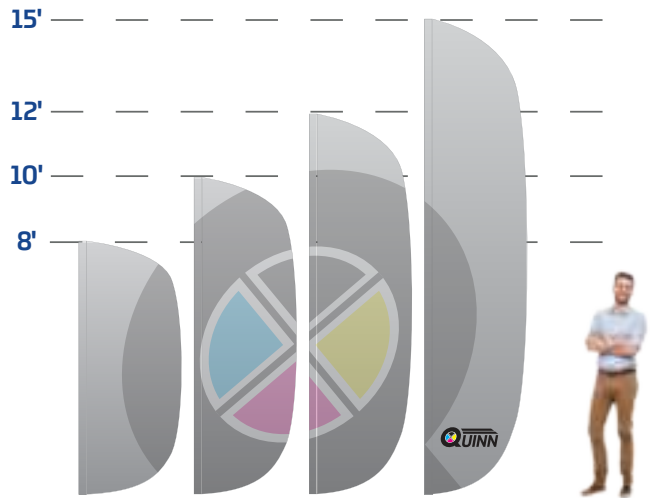

Hardware for Feather Flags

Telescoping feather flagpoles						
Item	Size	Fits Flag Sizes	1	6	12	25
HW15FTELPO	15'	8' / 10' / 12' feather flags	62.45	58.15	55.00	53.15
HW21FTELPO	21'	All 15' feather flags	74.40	71.90	68.75	65.00



Portable options for 15' and 21' feather flags

This 24.75" aluminum ground spike is designed for ease and portability for any feather flag shape. The premium ground spike provides a portable in-ground option.

Item	1	6	12	25
HW-SPIKE	38.90	33.75	28.50	26.10

This premium cross base comes with a removable ground spike that is 7" long for a sturdy mount for your banner.

Item	1	6	12	25
HW-CROSSBASE	71.90	61.40	56.90	49.10



*hardware imported

Windchaser Flag Kits

- Stationary
- Flag Rotates in the Wind
- Message is Always Visible
- Available in 3 Popular sizes

Markets: Sports, Schools, Real Estate, Trade Shows, Businesses, Restaurants

Uses: Events, Fairs, Festivals, Roadside Display

Windchaser Flags fly like a flag, yet stay open like a sign to keep your message always visible.

Material: Knit Polyester
 Usage: Outdoors
 Production time: 7-10 business days
 Finish: Pole sleeve across top & left side
 Made in USA: Yes
 Prop 65 WARNING: Cancer and/or Reproductive Harm. www.P65Warnings.ca.gov

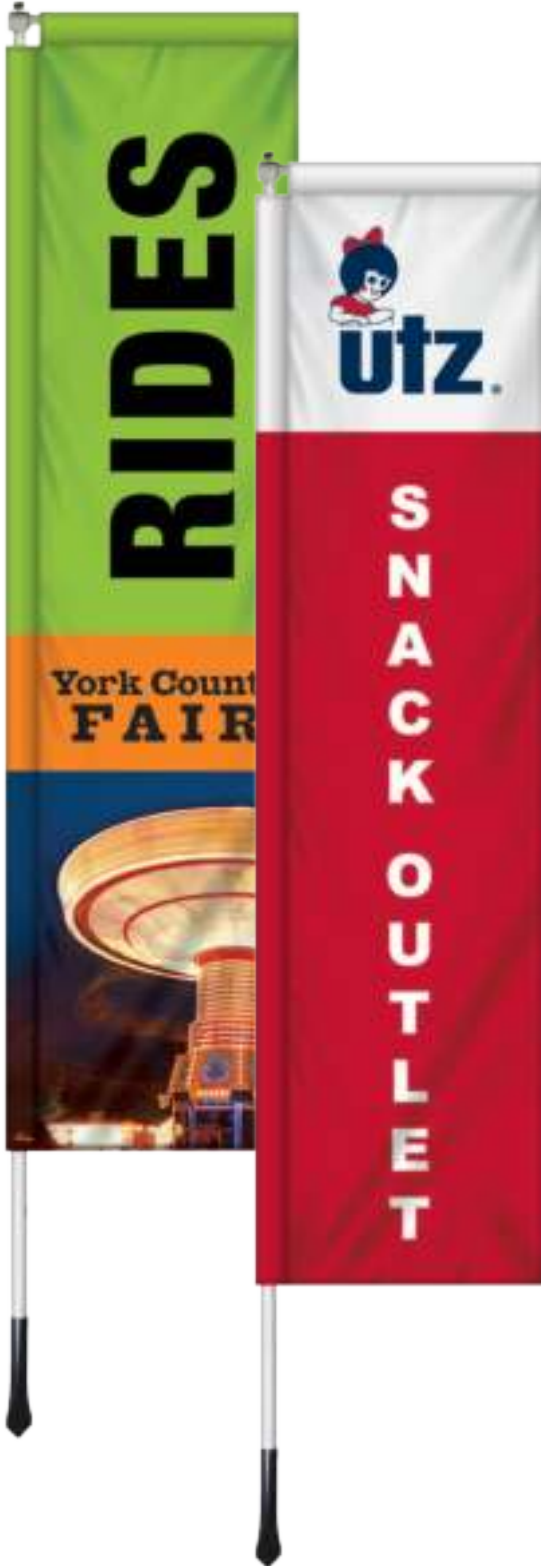

Single Reverse reads correct on one side and reversed on the backside.
 Double Sided reads correct on both sides and has a block-out liner in the center.

Kits with single reverse flag and hardware						
Item	Size	1	3	6	12	25
WC-8K	5'	173.65	130.25	112.60	94.00	77.65
WC-9K	8'	199.90	147.50	124.75	108.50	90.00
WC-13K	12'	233.65	182.50	149.50	133.00	112.25

Kits with double sided flag and hardware						
Item	Size	1	3	6	12	25
WC-D8K	5'	238.15	174.25	145.90	122.00	98.65
WC-D9K	8'	282.40	211.00	164.75	140.30	116.50
WC-D13K	12'	327.15	257.25	203.75	169.25	145.65



Replacement flags							
Item	Size	Sides	1	3	6	12	25
WC-8	5'	Single Reverse	120.00	78.50	61.70	46.50	35.00
WC-9	8'	Single Reverse	132.50	81.50	64.50	51.00	38.00
WC-13	12'	Single Reverse	152.50	102.75	72.50	58.75	43.50
WC-D8	5'	Double Sided	184.50	122.00	95.00	74.50	56.00
WC-D9	8'	Double Sided	215.00	145.00	101.50	79.80	61.50
WC-D13	12'	Double Sided	246.00	177.50	126.75	95.00	76.90

Replacement hardware						
Item	Product	1	2	5	11	16
WC-8-HW	For 5' Flags	53.65	52.25	50.90	47.50	45.40
WC-9-HW	For 8' Flags	67.40	66.00	63.25	60.50	57.75
WC-13-HW	For 12' Flags	81.15	79.75	77.00	74.25	71.50

*hardware imported



Tents

Grab attention at any event or location with highly customizable branding!

When determining which Tent best suits your client's needs...

Where will it be used? – Perfect for trade shows, tailgating, festivals, fairs and a variety of additional events, tents provide a durable, eye-catching solution for branding.

How will it be used/displayed? – With the option of spikes or weights to secure your tent, as well as a wheeled carry case for easy travel and set-up, tents can be displayed both indoor and outdoor.

How should messaging be presented? – Full color printing on the tent canopy provides optimal messaging, but additional accessories ranging from mountable banners, full walls and half walls, all of which have single reverse or double-sided options, allow for greater customization and branding impact.

What size? – We offer 10' x 10' and 10' x 20' and 6.5' x 6.5'. Contact us for pricing on additional customizations.

Why buy Tents from Quinn?

Quinn offers full color digital printing on all valances & peaks with no additional charges. One price regardless of art.

No Hidden Fees!



Tent frame, carrying case with wheels, spikes & rope included with every tent!

Tents

Markets: Trade Shows, Businesses, Food & Beverage, Sports

Uses: Events, Festivals, Fairs, Tailgating, Branding

Top Quality Branding at Great Prices!

Material: 600D Polyester / **Tent Frame:** Durable Aluminum Frame with Snap Lock Height Adjustments

Usage: Outdoors / Indoors

Production time: 7-10 business days

Finish: Sewn around all the edges to fit aluminum frame

Made in USA: No

Prop 65 WARNING: Cancer and/or Reproductive Harm. www.P65Warnings.ca.gov



CPT-1010

10' Square Standard Tents with Premium Canopy

10' x 10'

Item	1	3	6	12	25
CPT-1010	900.00	760.00	685.00	665.00	640.00

R

Art can be digitally printed on the inside or outside of full and half walls.

10' x 10' with walls

Item	Walls	1	3	6	12	25
CPT-3002T1K	1 Full	1190.00	1000.00	900.00	850.00	815.00
CPT-3002T1KD	1 Full / Double sided	1390.00	1165.00	1050.00	1000.00	960.00
CPT-3003T1K	1 Full, 2 Half	1545.00	1315.00	1180.00	1125.00	1080.00
CPT-3003T1KD	1 Full, 2 Half / Double sided	2100.00	1785.00	1610.00	1535.00	1475.00
CPT-3005T1K	3 Full	1830.00	1580.00	1400.00	1350.00	1300.00
CPT-3005T1KD	3 Full / Double sided	2265.00	1935.00	1760.00	1685.00	1635.00

R



CPT-3003T1KD

6.5' Square Standard Tents with Premium Canopy

6.5' x 6.5'

Item	1	3	6	12	25
CPT-6565	665.00	580.00	550.00	525.00	490.00

R

Art can be digitally printed on the inside or outside of full and half walls.

6.5' x 6.5' with walls

Item	Walls	1	3	6	12	25
CPT-6565W1K	1 Full	860.00	750.00	705.00	680.00	640.00
CPT-6565W1DK	1 Full / Double sided	990.00	850.00	775.00	750.00	725.00
CPT-6565W1H2K	1 Full, 2 Half	1100.00	900.00	850.00	800.00	750.00
CPT-6565W1DH2DK	1 Full, 2 Half / Double sided	1340.00	1175.00	1100.00	1020.00	955.00
CPT-6565W3K	3 Full	1225.00	1045.00	965.00	890.00	850.00
CPT-6565W3DK	3 Full / Double sided	1640.00	1420.00	1275.00	1240.00	1200.00

R



CPT-6565

CPT-6565W1DH2DK

10' x 20' Standard Tents with Premium Canopy

10' x 20'

Item	1	3	6	12	24
CPT-3001T2K	1725.00	1475.00	1335.00	1275.00	1225.00

R



CPT-3001BWK

CPT-3001T2K

NEW WALL OPTIONS

Art can be digitally printed on the inside or outside of full and half walls.

10' x 20' with walls

Item	Walls	1	3	6	12	25
CPT-3001BWK	1 Full	2165.00	1875.00	1690.00	1560.00	1495.00
CPT-3001DBWK	1 Full / Double sided	2550.00	2225.00	1950.00	1825.00	1775.00

R

Tents

Markets: Trade Shows, Businesses, Food & Beverage, Sports

Uses: Events, Festivals, Fairs, Tailgating, Branding

These heavy duty tents offer additional wind resistance and feature hexagon shape legs with easy press-button snap lock height adjustments.

Material: 600D Polyester / **Tent Frame:** Heavy Duty Aluminum 40mm Hexagon
Leg Frame with Easy Press Button Snap Lock Height Adjustments
Usage: Outdoors / Indoors
Production time: 7-10 business days
Finish: Sewn around all the edges to fit aluminum frame
Made in USA: No
Prop 65 WARNING: Cancer and/or Reproductive Harm. www.P65Warnings.ca.gov



CPT-1010HEX

10' Square Heavy Duty Tents with Premium Canopy

10' x 10'					
Item	1	3	6	12	25
CPT-1010HEX	995.00	885.00	830.00	800.00	775.00

R

Art can be digitally printed on the inside or outside of full and half walls.

10' x 10' with walls						
Item	Walls	1	3	6	12	25
CPT-1010HEXW1K	1 Full	1295.00	1125.00	995.00	950.00	900.00
CPT-1010HEXW1DK	1 Full / Double sided	1475.00	1250.00	1150.00	1100.00	1075.00
CPT-1010HEXW1H2K	1 Full, 2 Half	1750.00	1495.00	1350.00	1295.00	1230.00
CPT-1010HEXW1DH2DK	1 Full, 2 Half / Double sided	2185.00	1865.00	1680.00	1590.00	1535.00
CPT-1010HEXW3K	3 Full	2000.00	1750.00	1535.00	1450.00	1360.00
CPT-1010HEXW3DK	3 Full / Double sided	2500.00	2125.00	1940.00	1850.00	1800.00

R



CPT-1010HEXW1DK

10' x 20' Heavy Duty Tents with Premium Canopy

10' x 20'					
Item	1	3	6	12	25
CPT-1020HEX	1960.00	1750.00	1600.00	1535.00	1455.00

R



CPT-20HEXDBWK



CPT-1020HEX

NEW WALL OPTIONS

Art can be digitally printed on the inside or outside of full and half walls.

10' x 20' with walls						
Item	Walls	1	3	6	12	25
CPT-20HEXDBWK	1 Full	2400.00	2150.00	2000.00	1875.00	1795.00
CPT-20HEXDBWK	1 Full / Double sided	2800.00	2500.00	2325.00	2225.00	2125.00

R

STAND OUT With Accessories!

Tent Banners

Add an eye-catching Half Drop or Teardrop Tent Banner! Made from a durable polyester and customizable with a full-color digital imprint. Hardware available with purchase of a kit. Double sided banners are also available.

Tent Corner Banners

Add some flair and style to your tent without breaking the bank! Sold in sets, they easily attach with strong hook and loop fasteners.

Tent Weights and Sandbags

Keep your tent grounded and safe when displaying on a hard surface and cannot use ground spikes.



CPT-2000T2HK



CPT-10CBS

CPT-5001T2



CPT-5003T2





Advertising Banners, Wraps and Covers

Spread the word about your company with products custom-made for advertising needs!

When determining which Portable Banner best suits your client's needs...

Where will it be used? – Excellent for storefronts, corporate events or speeches, advertising banners cater to a diverse variety of uses, some specifically indoors and others specifically outdoors. Contact us for recommendations on what product would work best for your client's needs.

How will it be used/displayed? – While some products can be flown as outdoor promotional displays with reinforced grommets, others can be presented inside with a dowel and hanging cord. The use is specific to each product within the advertising banners, wraps & covers line.

How should messaging be presented? – Full color digital printing allows messaging to be printed on different products, with many having the capability to feature printing on both sides.

What size? – Containing a variety of sizes and cuts, advertising banners, wraps & covers offer adaptability for your client's needs. Contact us for more information on the specific products you'd like to know more about.

Avenue Banners

Vinyl Avenue Banners



Use for
TOWN EVENTS • PARKING LOTS
MUNICIPAL LIGHT POLES

Markets: Municipal, Shopping Malls, Auto Dealerships, Schools

Uses: Advertising, Branding, Decorating, Event Messaging

Have customers see your brand at every corner with this practical promotion! All Banners are Double Sided!

Material: 28 oz. Vinyl
Usage: Outdoors
Production time: 7-10 business days
Finish: Pole sleeve on the top & bottom with 1 grommet top & bottom
Made in USA: No
Prop 65 WARNING: Cancer and/or Reproductive Harm.
www.P65Warnings.ca.gov

Item	Size	1	3	6	12	25
VAB-3618	36" x 18"	136.90	94.00	69.30	62.30	51.55
VAB-5424	54" x 24"	161.90	114.70	98.05	88.25	69.00
VAB-6030	60" x 30"	208.00	133.55	112.80	101.65	88.15
VAB-7230	72" x 30"	248.00	157.20	126.00	111.35	98.30
VAB-9630	96" x 30"	292.00	196.05	156.90	137.30	123.30

R

Polyester Avenue Banners



Material: 600D Polyester
Usage: Outdoors
Production time: 7-10 business days
Finish: Pole sleeve on the top & bottom with 1 grommet top & bottom
Made in USA: No
Prop 65 WARNING: Cancer and/or Reproductive Harm.
www.P65Warnings.ca.gov

Item	Size	1	3	6	12	25
PAB-3618	36" x 18"	176.05	101.30	75.10	55.25	46.60
PAB-5424	54" x 24"	209.95	130.65	105.15	86.65	76.00
PAB-6029	60" x 29"	235.75	149.45	129.20	108.15	88.80
PAB-7229	72" x 29"	253.70	172.05	151.55	125.75	100.65
PAB-9629	96" x 29"	308.75	210.60	183.50	155.70	126.40

R

Hardware for Avenue Banners

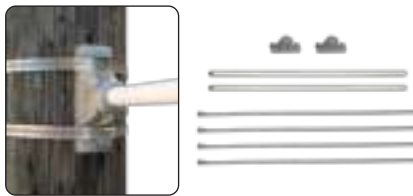

Item	Length	1	6	12	25	50
FMSS-18	18"	87.52	82.36	77.80	73.68	70.00
FMSS-24	24"	99.84	93.96	88.76	84.08	79.88
FMSS-30	30"	109.68	103.24	97.48	92.36	87.76
FMSS-36	36"	120.68	113.56	107.28	101.60	96.56

U

Premium Spring Loaded Hardware also available. Contact us for details.

Sunbrella™ Avenue Banners

Markets: Outdoors, Shopping Malls, Auto Dealerships, Schools

Uses: Parking Lots, College Stadiums, Sports Arenas, Town Light Poles

For those who only want high-end long-lasting Avenue and Light Pole Banners, Sunbrella™ material is the best in the industry. Used primarily for 1 and 2-spot color artwork. Best designs are simple so passersby can read and clearly see the brand/message.

Material: Sunbrella™
Usage: Outdoors
Production time: 12-15 business days
Finish: 3" fold-over pole sleeves at top and bottom / 1 grommet top and bottom below and above pole sleeve
Made in USA: Yes
Prop 65 WARNING: Cancer and/or Reproductive Harm. www.P65Warnings.ca.gov



For artwork with gradients and full digital color, please see our vinyl avenue banners. Sunbrellas™ are screen printed from a selection of available colors. Visit our website for more info.

Item	Number of colors	Size	2	3	6	12
CSAB-3818-1	1 color print	38" x 18"	362.50	261.91	155.60	119.30
CSAB-3818-2	2 color print	38" x 18"	641.15	443.95	246.90	170.80
CSAB-3818-3	3 color print	38" x 18"	901.89	614.35	432.70	228.25
CSAB-5423-1	1 color print	54" x 22"	459.50	339.60	215.70	169.30
CSAB-5423-2	2 color print	54" x 22"	742.95	528.65	318.67	232.30
CSAB-5423-3	3 color print	54" x 22"	1175.80	814.30	478.05	323.60

R

Item	Number of colors	Size	2	3	6	12
CSAB-6030-1	1 color print	60" x 30"	509.90	384.95	251.46	203.20
CSAB-6030-2	2 color print	60" x 30"	903.75	649.45	400.84	293.25
CSAB-6030-3	3 color print	38" x 18"	1291.85	910.10	553.96	385.05
CSAB-7223-1	1 color print	72" x 22"	516.55	390.75	256.15	207.68
CSAB-7223-2	2 color print	72" x 22"	914.20	656.06	404.60	296.85
CSAB-7223-3	3 color print	72" x 22"	1306.10	902.53	559.60	388.63
CSAB-7230-1	1 color print	72" x 30"	576.50	427.90	285.45	229.90
CSAB-7230-2	2 color print	72" x 30"	1020.69	721.71	454.70	330.45
CSAB-7230-3	3 color print	72" x 30"	1461.13	1010.85	626.80	440.65
CSAB-9630-1	1 color print	96" x 30"	722.10	539.95	364.76	302.80
CSAB-9630-2	2 color print	96" x 30"	1269.95	903.50	575.50	433.29
CSAB-9630-3	3 color print	96" x 30"	1770.20	1260.45	778.25	563.80

R

Advertising Banners



Polyester

Polyester Mesh

Markets: Sports, Schools, Retail, Construction, Safety, Businesses

Uses: Advertising, Branding, Event Messaging

Advertise your brand and message almost anywhere with eye-popping full color graphics! Vinyl banners are single sided. Polyester and polyester mesh banners are single reverse.

Any Shape or Size!

Polyester

Material: 4 oz. Knit Polyester
Usage: Outdoor
Production time: 7-10 business days
Finish: 1 Grommet in each corner
Made in USA: Yes



Polyester					
Item	Size	1	2	6	12
FCPB-2001T1	2' x 6'	124.35	89.25	56.20	34.80
FCPB-2002T1	3' x 6'	139.75	101.85	84.30	46.40
FCPB-2003T1	3' x 8'	156.20	126.25	100.45	57.60
FCPB-2004T1	3' x 15'	260.40	186.00	171.00	138.65
FCPB-2005T1	4' x 10'	249.35	176.20	151.95	119.25
FCPB-2006T1	4' x 20'	327.00	244.85	193.50	163.30

Polyester Mesh

Material: 120 g. Polyester Mesh
Usage: Outdoor
Production time: 7-10 business days
Finish: Reinforced corners with canvas header hemmed into edges and grommets at corners plus 3" out from corner and every foot
Made in USA: No

Polyester mesh					
Item	Size	1	2	6	12
PMB-412	4' x 12'	223.95	177.50	135.25	123.25
PMB-424	4' x 24'	341.00	286.45	238.90	216.45
PMB-448	4' x 48'	579.25	521.50	451.40	413.75
PMB-512	5' x 12'	256.30	205.05	159.25	144.90
PMB-524	5' x 24'	394.50	333.05	285.10	257.40
PMB-548	5' x 48'	674.15	598.20	523.70	485.65
PMB-612	6' x 12'	313.10	258.40	199.35	185.60
PMB-624	6' x 24'	510.70	435.25	363.85	341.50
PMB-648	6' x 48'	877.05	811.30	703.65	673.60

Vinyl

Material: 13 oz. Vinyl
Usage: Outdoor
Production time: 7-10 business days
Finish: 1 Grommet in each corner
Made in USA: No
Prop 65 WARNING: Cancer and/or Reproductive Harm. www.P65Warnings.ca.gov

Vinyl						
Item	Size	1	3	5	10	25
VB-026	2' x 6'	148.00	103.65	74.40	65.95	49.00
VB-036	3' x 6'	172.00	113.25	93.00	77.20	57.90
VB-038	3' x 8'	180.00	128.45	108.20	88.25	79.40
VB-315	3' x 15'	288.00	214.65	157.55	126.05	114.35
VB-410	4' x 10'	260.00	199.45	142.40	121.00	104.70
VB-420	4' x 20'	398.85	312.75	220.00	198.00	188.05

Giant Flagpole Kits



Assembles in Minutes
No Additional Tools Required

Markets: Sports, Schools, Automotive, Businesses

Uses: Events, Festivals, Fairs, Tailgating, Advertising

Create a WOW moment with our Giant Flagpoles. No doubt you will be noticed!



Material: Knit Polyester
Usage: Outdoors
Production time: 7-10 business days
Finish: Sewn around all the edges to fit aluminum frame
Made in USA: Yes
Prop 65 WARNING: Cancer and/or Reproductive Harm. www.P65Warnings.ca.gov

Single Reverse reads correct on one side and reversed on the backside.
 Double Sided reads correct on both sides and has a block-out liner in the center.

Kit with flag and hardware							
Item	Size	Sides	1	3	6	12	25
GFP-1001T2K	8'	Single Reverse	436.02	380.55	283.71	268.62	246.79
GFP-1001T2KD	8'	Double Sided	517.14	420.75	326.37	303.18	272.85
GFP-1002T2K	10'	Single Reverse	449.54	392.35	295.12	277.09	253.46
GFP-1002T2KD	10'	Double Sided	540.80	440.00	348.19	319.57	285.11
GFP-1003T2K	13'	Single Reverse	476.58	387.75	310.00	291.13	266.34
GFP-1003T2KD	13'	Double Sided	628.68	492.90	386.88	352.42	318.38

Replacement flags							
Item	Size	Sides	1	3	6	12	25
GFP-1001T2R	8'	Single Reverse	152.00	128.44	79.09	63.00	44.83
GFP-1001T2DR	8'	Double Sided	248.00	209.56	127.89	95.70	77.38
GFP-1002T2R	10'	Single Reverse	168.00	141.96	94.64	74.03	52.80
GFP-1002T2DR	10'	Double Sided	276.00	217.35	155.61	114.40	85.81
GFP-1003T2R	13'	Single Reverse	200.00	169.00	107.10	86.44	65.72
GFP-1003T2DR	13'	Double Sided	351.50	299.25	191.75	152.91	122.21

*hardware imported

Podium Banners



Straight Cut



V Cut



Angle Cut



Many More Sizes and Shapes Available

Markets: Trade Shows, Schools, Municipal, Businesses, Financial, Political

Uses: Conferences, Banquets, Ceremonies, Awards, Motivational

This banner will show off the very best of your brand with either a straight bottom or fringe!

Material: Satin Polyester

Usage: Indoors

Production time: 7-10 business days

Finish: Heat cut edges

Made in USA: No

Prop 65 WARNING: Cancer and/or Reproductive Harm.

www.P65Warnings.ca.gov

Prices listed below are for Banners with NO FRINGE. If interested in Fringe, please contact us for details.

Straight cut					
Item	Size	6	12	25	50
DPPB-2230S	22" x 30"	64.90	46.20	26.90	18.55
DPPB-2648S	26" x 48"	65.20	47.60	29.25	23.10
DPPB-3054S	30" x 54"	80.95	60.00	35.30	27.95
DPPB-4260S	42" x 60"	103.35	66.95	56.25	39.80

Straight cut (giveaway sizes)					
Item	Size	12	25	50	100
DPPB-69S	6" x 9"	27.75	14.45	9.15	7.32
DPPB-710S	7" x 10"	28.10	14.65	9.20	7.36
DPPB-812S	8" x 12"	28.00	15.70	11.95	9.56
DPPB-1420S	14" x 20"	29.10	16.65	12.30	9.84

V cut					
Item	Size	6	12	25	50
DPPB-2230V	22" x 30"	64.90	46.20	26.90	18.55
DPPB-2648V	26" x 48"	65.20	47.60	29.25	23.10
DPPB-3054V	30" x 54"	80.95	60.00	35.30	27.95
DPPB-4260V	42" x 60"	103.35	66.95	56.25	39.80

V cut (giveaway sizes)					
Item	Size	12	25	50	100
DPPB-69V	6" x 9"	27.75	14.45	9.15	7.32
DPPB-710V	7" x 10"	28.10	14.65	9.20	7.36
DPPB-812V	8" x 12"	28.00	15.70	11.95	9.56
DPPB-1420V	14" x 20"	29.10	16.65	12.30	9.84

Angle cut					
Item	Size	6	12	25	50
DPPB-2230B	22" x 30"	64.90	46.20	26.90	18.55
DPPB-2648B	26" x 48"	65.20	47.60	29.25	23.10
DPPB-3054B	30" x 54"	80.95	60.00	35.30	27.95
DPPB-4260B	42" x 60"	103.35	66.95	56.25	39.80

Angle cut (giveaway sizes)					
Item	Size	12	25	50	100
DPPB-69B	6" x 9"	27.75	14.45	9.15	7.32
DPPB-710B	7" x 10"	28.10	14.65	9.20	7.36
DPPB-812B	8" x 12"	28.00	15.70	11.95	9.56
DPPB-1420B	14" x 20"	29.10	16.65	12.30	9.84

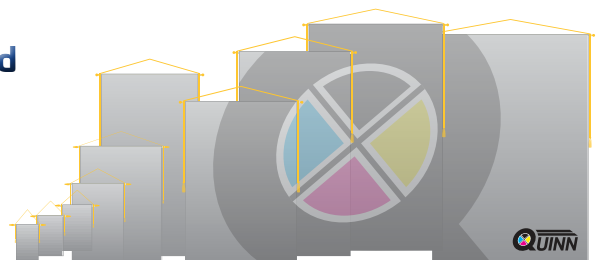

Multi-Use Stretch Band Ideas



Markets: Trade Shows, Retail, Auto Dealerships, Schools, Businesses, Municipal, Political, Real Estate, Tourism

Uses: Giveaways, Events, Advertising, Branding

Brand or add your message to any object with these unique stretch polyester bands. Multi-use stretch bands can be used to wrap just about any object with full color digital graphics.

Material: Stretch Polyester
Usage: Outdoors / Indoors
Production time: 7-10 business days
Finish: Sewn edges
Made in USA: Yes



Item	1
MUSB-4000	Call for price

Wrap growlers, mugs and kegs at the local brewery or wrap garbage cans, tanks and cylinders at events

Chair Covers

NEW



Markets: Event Marketing, Schools, Sports, Retail, Businesses, Political

Uses: Events, Advertising, Branding

Add some color, confare and cheer to cover up folding chairs and stadium seats. Use a few to promote, advertise and stand out, or utilize many to create a beautiful and vibrant display that will catch all eyes.

Material: Stretch Polyester
Usage: Outdoors / Indoors
Production time: 7-10 business days
Finish: Sewn edges
Made in USA: No

Item	Fits (Most)	12	25	50	100	250
CBF-01	Standard folding chair	20.50	14.85	12.00	10.35	8.90
CBS-01	Standard stadium seat	26.55	21.00	17.55	15.45	13.00

Small Item Wraps



Markets: Event Marketing, Retail, Businesses, Political, Real Estate, Sports

Uses: Giveaways, Branding, Grand Openings, Advertising

The perfect alternative to etched glass or low-quality custom plastic glasses.

Material: Stretch Polyester
Usage: Outdoors / Indoors
Production time: 7-10 business days
Finish: Sewn edges
Made in USA: No

Item	Fits (Most)	25	50	100	250	500
BW-1	12 oz long neck bottle	10.00	6.65	4.80	3.65	2.90
CW-1	12 oz can	10.00	6.65	4.80	3.65	2.90
STCW-1	12 oz slim tall can	10.00	6.65	4.80	3.65	2.90
PGW-1	16 oz pint glass	10.00	6.65	4.80	3.65	2.90

R

Marking and Utility Flags



Plastic and
Fiberglass Staffs
Available

High Gloss Flags
Also Available



Markets: Construction, Organizations, Safety

Uses: Buried Cables, Construction Sites, Caution Areas

These 1-color custom marking flags are an ideal way to flag down new business!

Material: Vinyl
Usage: Outdoors
Production time: 14 business days
Finish: Mounted to a wire staff
Made in USA: Yes
Prop 65 WARNING: Cancer and/or Reproductive Harm.
www.P65Warnings.ca.gov



Minimum order is 1,000 flags per case.
2 Color also available. Call for more details.

Item	Flag size	Staff size	1000	3000	6000	12000	25000
1500	2.5' x 3.5"	11.5'	0.232	0.207	0.192	0.179	0.165
1510	4' x 5"	15"	0.249	0.234	0.220	0.202	0.190
1515	4' x 5"	18"	0.262	0.250	0.232	0.212	0.200
1520	4' x 5"	21"	0.263	0.254	0.239	0.220	0.209
1525	4' x 5"	24"	0.271	0.260	0.247	0.227	0.215
1530	4' x 5"	30"	0.286	0.275	0.260	0.242	0.226
1535	4' x 5"	36"	0.308	0.302	0.287	0.267	0.250
1540	5' x 8"	30"	0.320	0.310	0.297	0.274	0.255
1545	5' x 8"	36"	0.345	0.333	0.316	0.294	0.277

Imprint Options



Background Flag Options



Metal Desk Sets

Markets: Education, Organizations

Uses: Branding, Schools, Offices, Trade Shows

These 11-19.7" metal telescopic flagpole banners are a simple metal desk accessory that provides a sophisticated look sure to gain maximum brand exposure. A simple and sleek design allows you to switch flags and banners easily at trade shows, fundraisers, corporate promotions and much more.

Material: Polyester / Metal
Usage: Indoors
Production time: 7-10 business days
Finish: Sewn around the edges
Made in USA: No
Prop 65 WARNING: Cancer and/or Reproductive Harm.
www.P65Warnings.ca.gov



Other shapes and styles are available on request. Minimum quantity of 12 per order.

Single Reverse reads correct on one side and reversed on the backside. Double Sided reads correct on both sides and has a block-out liner in the center.

Single reverse / telescopic pole extends from 11" to 19.7"						
Item	Flag Size	12	25	50	100	250
DSF29S	5.5' x 8"	43.50	35.10	25.80	20.70	17.80
DSF32S	8' x 12"	48.50	38.80	30.30	27.25	24.60
DSF28S	5.49' x 8.27"	47.50	36.90	26.65	23.00	18.70

Double sided / telescopic pole extends from 11" to 19.7"						
Item	Flag Size	12	25	50	100	250
DSF29D	5.5' x 8"	44.50	36.10	26.40	21.20	18.20
DSF32D	8' x 12"	49.50	39.60	31.65	28.50	25.65
DSF28D	5.49' x 8.27"	48.50	37.90	27.25	23.50	19.10

*hardware imported

Mini Teardrop Banners



Markets: Trade Shows, Retail, Food & Beverage, Businesses, Financial, Healthcare

Uses: Office Cubicles, Retail Aisles, Warehouse Labeling

There's nothing mini about the impression your brand will make with these Mini Teardrop Banners. Decorate your desktop, store or cubicle in style.

Material: Polyester

Usage: Indoors

Production time: 7-10 business days

Finish: Black nylon pole sleeve

Made in USA: Yes (except PTBM-200LG, PTBM-200DLG)

Prop 65 WARNING: Cancer and/or Reproductive Harm. www.P65Warnings.ca.gov



Single Reverse reads correct on one side and reversed on the backside.
Double Sided reads correct on both sides and has a block-out liner in the center.

Clip

Hardware set includes a rod and plastic clip (opening to 1.5") that keeps the display steady. Flag size is 11" x 21". Total assembly height is 30".

Item	Sides	6	12	25	50	100
PTBM-400	Single Reverse	50.80	36.85	26.60	20.20	16.20
PTBM-400D	Double Sided	67.50	49.50	36.50	27.25	21.50

R

Suction

Hardware set includes rod and a heavy duty suction cup. This product can be attached to multiple hard surfaces or the suction cup can be used as a tabletop base, providing a versatile product in a variety of settings. Flag size is 11" x 21". Total assembly height is 29".

Item	Sides	6	12	25	50	100
PTBM-110	Single Reverse	54.95	38.95	31.95	24.99	19.95
PTBM-110D	Double Sided	69.10	56.10	41.85	34.15	28.50

R

Desktop

Hardware set includes a black carrying case, fiberglass rod and attractive weighted screw base that keeps display steady.

Mini Desktop Teardrop flag size is 9" x 14" (assembled size 11" x 18").

Desktop Teardrop flag size is 12.25" x 24.5" (assembled size 15" x 29").

Item	Sides	6	12	25	50	100
PTBM-200	Single Reverse	48.30	34.85	27.10	22.00	18.95
PTBM-200D	Double Sided	53.40	41.90	31.10	25.70	22.65
PTBM-200LG	Single Reverse	56.60	41.10	32.70	27.05	20.75
PTBM-200DLG	Double Sided	63.05	48.65	37.60	31.20	24.55

R

*hardware imported



Clip

Suction Cup

Desktop Base

Non-Woven Tote Bags



Perfect size to fit samples and literature!

Markets: Trade Shows, Businesses, Grocery, Real Estate, Schools, Sports, Retail

Uses: Giveaways, Branding, Fundraising, Advertising

These full color non-woven polypropylene bags are the perfect way to promote your brand.

Material: Non-Woven Polypropylene

Usage: Indoors

Production time: 7-10 business days

Finish: Gloss or Matte

Made in USA: No

Prop 65 WARNING: Cancer and/or Reproductive Harm. www.P65Warnings.ca.gov

Item	Size	5000	10000	15000
NWBAG-1013	13.5" H x 3.5" W x 10.5" L	3.30	3.05	2.90

R

Show off your school spirit with banners, wearables and more!

When determining which School Spirit product best suits your client's needs...

Where will it be used? – Versatile as an ideal means of branding for giveaways, tailgating, conventions or sporting events, the school spirit line offers an assorted range of products catered to varying uses. Contact us for recommendations on what product would work best for your client's needs.

How will it be used/displayed? – Some products in the school spirit line can be displayed as wearables, some as stationary branding and some as banners that can be moved around. The use is specific to each product within the school spirit line.

How should messaging be presented? – Messaging can be printed through full-color imprinting on elastic wearables, on single reverse or double-sided banners or on polyester scarves. The way your messaging can be presented changes with every product in the school spirit line.

What size? – Ranging from pens with pull-out banners to massive stadium banners that can be used to promote your messaging on a field, products within the school spirit line come in a variety of sizes. Contact us for more information on the specific products you'd like to know more about.



School Spirit and Wearables

Markets: Schools, Sports, Businesses

Uses: Events, Giveaways, Branding, Advertising, Tournaments, Fairs, Festivals

Show off your team spirit at your next event with a stadium scarf, bandana, arms sleeves or any of our other wearable products!



Wearables

Multifunctional Headwear



This multi-purpose wearable is a stylish accessory for showing off a favorite brand, sports team, company or awareness organization. It can be used as a face mask, neckerchief, bandana, wristband, hood, hair tie and more.

Material: Various
Usage: To be worn
Production time: 15-20 business days
Finish: Sewn around the edges
Made in USA: No

Item	Ply	Material	Coating/Treatment	100	250	500	1000	2500
MFH-919	1	Stretch Polyester	None	6.70	4.60	3.85	3.35	2.90
MFHP-1014	1	4-direction Stretch Fabric	Anti Microbial treatment and UPF 50 coating	7.70	5.85	4.75	4.15	3.25
MFHP2-1014	2	4-direction Stretch Fabric	Anti Microbial treatment and UPF 50 coating	14.00	9.85	8.50	7.05	6.10
MFHF-1014	1	Polyester/Fleece	None	8.35	6.20	5.45	4.85	3.85

R

Knit Beanies



BPC-N1R



BN-P1



BPC-E1



BPC-W1R

Stay warm and promote your brand, team or organization! Made from high quality acrylic blended jacquard materials and available with or without pom and cuff. For additional branding, choose embroidered or printed/woven patches.

Material: Acrylic (san)
Usage: To be worn
Production time: 25 business days
Finish: Sewn around the edges
Made in USA: No
Prop 65 WARNING: Cancer and/or Reproductive Harm.
www.P65Warnings.ca.gov

Beanie					
Item	2" Logo	250	500	1000	2000
BN-N1	None	8.30	7.60	7.15	5.75
BN-P1	Printed	8.75	8.00	7.50	6.05
BN-W1	Woven	8.75	8.00	7.50	6.05
BN-E1	Embroidered	9.10	8.35	7.85	6.40

R

Beanie with pom and cuff					
Item	2" Logo	250	500	1000	2000
BPC-N1 / BPC-N1R (ribbed cuff)	None	11.60	10.75	10.20	8.80
BPC-P1 / BPC-P1R (ribbed cuff)	Printed	12.05	11.15	10.60	9.20
BPC-W1 / BPC-W1R (ribbed cuff)	Woven	12.05	11.15	10.60	9.20
BPC-E1 / BPC-E1R (ribbed cuff)	Embroidered	12.35	11.50	10.90	9.50

R

Stadium Scarves



Have your clients get in the spirit at trade shows, conventions, sporting events and much more!

Material: Polyester Satin
Usage: To be worn
Production time: 12-15 business days
Finish: Sewn around the edges
Made in USA: No
Prop 65 WARNING: Cancer and/or Reproductive Harm.
www.P65Warnings.ca.gov

Item	Size	24	50	100	250	500
SSC-557	55" x 7"	16.45	15.35	11.75	9.60	9.15

R

Wearables

Arm Sleeves



This eye-catching item is ideal for sporting events either as a spectator or a player. Multiple sizes are available - please inquire for custom sizes.

Material: Stretch Polyester
Sold in sets of 2
Usage: To be worn
Production time: 12–15 business days
Finish: Sewn around the edges
Made in USA: No
Prop 65 WARNING: Cancer and/or Reproductive Harm. www.P65Warnings.ca.gov

Item	Size	Width	100	250	500	1000	2500
SAS-11P	11"	3.75" Top, 3" Bottom	7.35	5.00	4.35	3.60	3.50
SAS-15	15"	4.3" Top, 3.3" Bottom	7.85	6.15	5.20	4.50	3.85

R

Arm Bands



Great for school spirit functions, sporting events, awareness programs and so much more.

Material: Polyester
Usage: To be worn
Production time: 15–17 business days
Finish: Closed with attached fastener
Made in USA: No
Prop 65 WARNING: Cancer and/or Reproductive Harm. www.P65Warnings.ca.gov

Item	Size	100	250	500	1000	2500
SARMB-13	13" x 3.7"	6.00	4.00	3.50	3.00	2.40

R

Bandanas



Create a lasting promotion for your business with these multi-purpose and reusable bandanas. Can be worn as a wristband, a head wrap, a neck warmer, a rally towel and so much more.

Material: Microfiber Polyester
Usage: To be worn
Production time: 15–17 business days
Finish: Sewn around the edges
Made in USA: No
Prop 65 WARNING: Cancer and/or Reproductive Harm. www.P65Warnings.ca.gov

Item	Size	100	250	500	1000	2500
BANDANA-22	22" x 22"	6.75	4.85	4.10	3.35	3.00

R

Body Flags



Front View



Back View

Ideal for schools, athletic clubs and professional teams, this wow-worthy wearable is a great way to show pride.

Material: 100D Polyester
Usage: To be worn
Production time: 7–10 business days
Finish: Sewn around the edges
Made in USA: No

Item	Size	25	50	100	250	500
SBF-35	3' x 5'	37.00	29.20	24.45	20.65	16.90

R

Scroll Banners

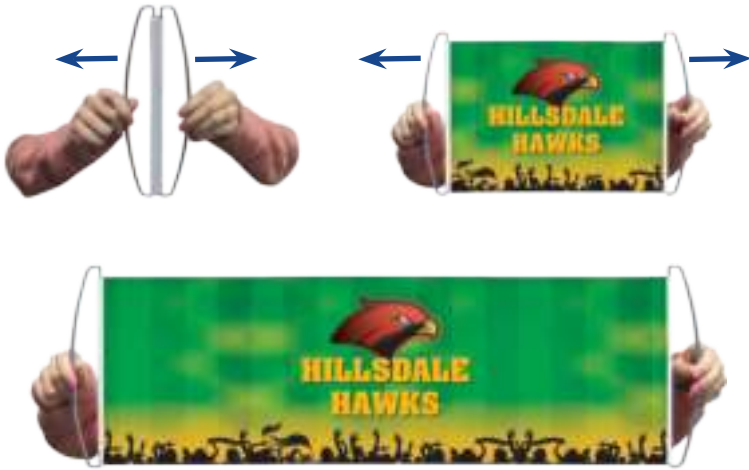

Don't scroll past this item! This is an eye-catching, affordable way to get your message across.

Material: Polyethylene
Usage: Outdoors / Indoors
Production time: 12-15 business days
Finish: Mounted to plastic handles
Made in USA: No
Prop 65 WARNING: Cancer and/or Reproductive Harm.
www.P65Warnings.ca.gov

Item	Sides	250	500	1000	2500
SCROLLBANNER-1	Single Sided	8.70	5.75	3.45	2.20
SCROLLBANNER-2	Double Sided	11.55	6.75	4.00	2.45

R

Customizable with a 4-color process imprint. Please contact us for a quote if your design requires more than 4 colors.

Quiet · Safe · Compact · Affordable

Fan Flags



Increase audience participation by passing these out at speeches, rallies, holiday parties and much more.

Material: Polyester
Usage: Outdoors / Indoors
Production time: 7-10 business days
Finish: Hemmed edges
Made in USA: No
Prop 65 WARNING: Cancer and/or Reproductive Harm.
www.P65Warnings.ca.gov

Item	Size	25	50	100	250	500
DPSF-8121001	8" x 12"	9.98	7.35	4.90	3.55	2.75
DPSF-12181001	12" x 18"	13.25	7.95	6.80	4.75	3.60

R

Affordable and Long Lasting

Premium Gonfalons

Premium Display Polyester Gonfalons are ceremonial banners hung from a crossbar, perfect for ceremonies, graduations, religious events, championships, and much more.

Material: Premium Display Polyester
Usage: Indoors
Production time: 7-10 business days
Finish: 3" pole sleeve with middle notch cut in back to fit hardware
Made in USA: Yes



Prices listed below are for Banners with NO FRINGE. If interested in Fringe, please contact us for details.

Premium 7' gonfalon kits						
Item	Size	Cut	1	3	6	12
GF-3048VK1	30" x 48"	V-Cut	501.50	383.00	340.50	312.50
GF-3048SK1	30" x 48"	Straight Cut	501.50	383.00	340.50	312.50
GF-3660VK1	36" x 60"	V-Cut	548.50	433.50	365.50	334.50
GF-3660SK1	36" x 60"	Straight Cut	548.50	433.50	365.50	334.50
GF-3672VK1	36" x 72"	V-Cut	593.00	460.50	382.50	346.50
GF-3672SK1	36" x 72"	Straight Cut	593.00	460.50	382.50	346.50

R

Fringe and 8' Gonfalon Kits also available



Back View

Breakaway Banners



Create a promotional display that's ideal for a variety of events and occasions.

Material: Knit Polyester
Usage: Outdoor
Production time: 7-10 business days
Finish: Pole sleeve on left & right sewn closed at the top
Made in USA: Yes

Item	Size	1	3
CBB-412	4' x 12'	264.95	186.20
CBB-512	5' x 12'	280.00	198.15

R



Hook and Loop Fastener Offers Easy Break Away

School Spirit Flags



They'll feel the spirit as soon as they see this knit polyester school spirit flag parading across any field!

Material: Knit Polyester
Usage: Outdoors
Production time: 7-10 business days
Finish: Pole sleeve to fit 1" diameter pole and sewn closed at the top
Made in USA: Yes



Single Reverse reads correct on one side and reversed on the backside.
 Double Sided reads correct on both sides and has a block-out liner in the center.

Flags					
Item	Size	Sides	1	3	6
SSF-56-SR	5' x 6'	Single Reverse	249.40	173.45	149.40
SSF-56-DS	5' x 6'	Double Sided	349.40	243.15	218.15
SSF-68-SR	6' x 8'	Single Reverse	280.00	198.15	168.15
SSF-68-DS	6' x 8'	Double Sided	392.45	277.45	245.65

R



Hardware					
Item	Color	Size	1	12	24
ADP-800CS	Silver	8'	23.96	22.80	21.68
ADP-1000CS	Silver	10'	35.50	-	-

U

*hardware imported

Felt Pennants



Go with the classic look of authentic felt pennants! Hang it around your dorm, your place of business or pass it out as a souvenir.

Material: Felt
 Usage: Indoors
 Production time: 7–10 business days
 Finish: Sewn on header
 Made in USA: No

Item	Size	Orientation	100	250	500	1000	2500
DFP-410	4" x 10"	Horizontal	5.00	3.10	2.00	1.50	1.10
DFP-512	5" x 12"	Horizontal	5.25	3.40	2.60	1.80	1.40
DFP-818	8" x 18"	Horizontal	6.25	4.80	3.80	2.85	2.40
DFP-924	9" x 24"	Horizontal	7.10	5.55	4.25	3.50	3.00
DFP-1230	12" x 30"	Horizontal	8.75	7.15	5.25	4.35	3.85
FTP-1420	14" x 20"	Vertical	9.45	6.65	5.00	4.00	3.20
FTP-2436	24" x 36"	Vertical	23.90	18.50	13.95	11.85	10.70
FTP-3048	30" x 48"	Vertical	37.15	28.00	23.80	20.25	18.25

R

Wooden Dowels Available!

Contact us for details.

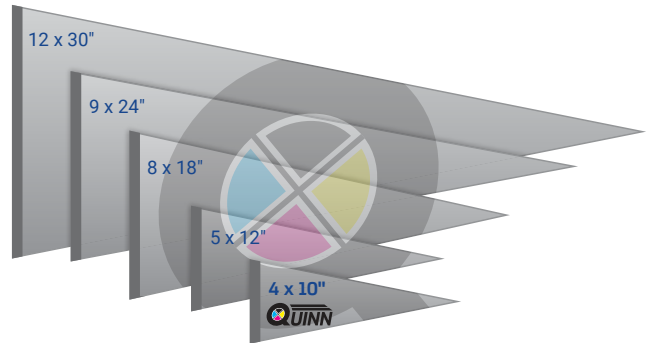

Felt Banners



This Banner can be hung vertically or horizontally, creating a versatile product for an endless number of branding and advertising purposes. Any shape or size available. Please inquire.

Material: Felt
 Usage: Indoors
 Production time: 7–10 business days
 Finish: Heat cut edges with a pole sleeve
 Made in USA: No

Item	Size	100	250	500	1000	2500
FRB-1420	14" x 20"	11.75	8.80	7.00	5.25	4.45
FRB-2436	24" x 36"	23.30	18.65	14.95	12.75	11.50
FRB-3048	30" x 48"	38.50	28.90	24.60	21.60	19.00

R

From spirit sales to delivery services and beyond, car flags are great for advertising a product, service or message!

When determining which Car Flags & Auto Accessories best suits your client's needs...

Where will it be used? – Suitable for indoor and outdoor use, car flags are great for promotional opportunities that range from corporate branding, to delivery services, to awareness events and so forth.

How will it be used/displayed? – Certain car flags are designed for stationary use while others can be used at highway speeds. Let us know how the car flags will be used so we can recommend which will work best!

How should messaging be presented? – Offering both single-ply and double-sided imprinting. With a variety of shapes to choose from, several options are available for maximizing the impact of your branding or messaging.

What size? – Standard sizes are 7.5" x 10" and 11.5" x 15" for stationary or highway use, while additional half drop and teardrop options are available, with the capability of a variety of shapes for all.



Auto Accessories

Car Stretch Products

Markets: Auto Dealerships, Fundraisers, Schools, Delivery, Ride Share, Sports, Businesses

Uses: Advertising, Branding, Giveaways

Put your message on something that's built for the road with these promotional items! Our automotive products are made from stretch polyester that slips easily over headrests, mirrors or fuel doors in cars, SUVs, trucks and more.

Material: Stretch Polyester

Usage: Outdoors

Production time: 7–10 business days

Finish: Sewn around the edges

Made in USA: No

Prop 65 WARNING: Cancer and/or Reproductive Harm.

www.P65Warnings.ca.gov



Fuel Door Covers

An elastic band holds the cover and can be used with both round and square fuel doors. Cover will remain on while you drive.

Item	Fits fuel door sizes	100	200	300	400	500
CCGC-89	6.5 x 6.5" - 8.25 x 9.25"	6.55	4.60	3.75	3.35	3.05

R

Headrest Covers

Sold in pairs, allowing you to completely outfit any vehicle.

Item	Size	100	200	300	400	500
CCHRC-99	9" x 9.84"	10.45	8.30	6.60	5.99	5.25

R

Mirror Covers

An elastic band holds it in place on the outside car mirrors of your vehicle. Intended for stationary and parade use only. Sold in pairs.

Item	Size	100	200	300	400	500
CCMC-SM	10.63" x 9.5"	8.50	6.60	6.00	5.10	4.70
CCMC-LG	11.81" x 9.5"	9.00	6.80	6.45	5.65	5.35

R

Promotional Car Flags



Custom printed car flags are great for spirit sales, corporate branding, delivery services, auto dealerships, awareness events, college bookstores and more.

Material: 100D Polyester
Usage: Outdoors
Production time: 10–15 business days
Finish: Mounted to Economy car flag staff
Made in USA: No
Prop 65 WARNING: Cancer and/or Reproductive Harm.
www.P65Warnings.ca.gov

Our car flags with a 15" Economy Flex Staff are great for those with a certain budget and is standard for stationary and parade use.

Economy staff			100	250	500	1000	2500
Item	Size	Sides					
CCFP-75E	7.5" x 10.5"	Single Reverse	5.30	4.00	3.30	2.75	2.40
CCFP-115E	11.5" x 15"	Single Reverse	6.60	4.95	4.00	3.60	3.30

R

Traditional Car Flags



Material: Knit Polyester
Usage: Outdoors
Production time: 7–10 business days
Finish: Mounted to Economy / Premium car flag staff
Made in USA: Yes
Prop 65 WARNING: Cancer and/or Reproductive Harm. www.P65Warnings.ca.gov



Single Reverse reads correct on one side and reversed on the backside.
 Double Sided reads correct on both sides and has a block-out liner in the center.

Our car flags with a 15" Economy Flex Staff are great for those with a certain budget and is standard for stationary and parade use.

Economy staff			6	12	25	50	100
Item	Size	Sides					
CCFP-75S	7.5" x 10.5"	Single Reverse	24.35	20.00	15.60	10.25	7.20
CCFP-75D	7.5" x 10.5"	Double Sided	28.10	23.75	18.75	13.35	9.35

R

Our car flags with a Premium Staff are great for any use including standard highway speeds.

Premium staff			6	12	25	50	100
Item	Size	Sides					
CCFP-75PS	7.5" x 10.5"	Single Reverse	29.50	24.25	18.75	10.95	7.70
CCFP-115S	11.5" x 15"	Single Reverse	38.35	31.50	24.40	13.75	9.65
CCFP-75PD	7.5" x 10.5"	Double Sided	33.75	28.50	22.50	14.75	10.35
CCFP-115D	11.5" x 15"	Double Sided	43.90	37.05	29.25	17.95	12.60

R

Magnetic Car Flags



This magnetic car flag is an effective alternative to a traditional window style car flag.

Material: Knit Polyester
Usage: Outdoors
Production time: 7–10 business days
Finish: Pole sleeve to fit hardware / mounted to staff with magnetic base
Made in USA: Yes
Prop 65 WARNING: Cancer and/or Reproductive Harm. www.P65Warnings.ca.gov



Single Reverse reads correct on one side and reversed on the backside.
 Double Sided reads correct on both sides and has a block-out liner in the center.

Item	Size	Sides	6	12	25	50	100
WMMF-1001T2K	5.5" x 8.25"	Single Reverse	38.80	28.54	26.25	22.35	20.25
WMMF-1001T2KD	5.5" x 8.25"	Double Sided	43.60	32.07	29.60	26.65	25.30

R

*hardware imported



Pennant Strings

Spice up your event and POP area with branding everywhere you look!

When determining which Pennant String best suits your client's needs...

Where will it be used? – If being used outdoor in any weather condition and longer-term use, PVC is the best material but shorter use material options are available. Contact us for pricing.

How will it be used/displayed? – Knowing the space your pennant string will be displayed will help determine the length for each string and how many will be needed.

How should messaging be presented? – Multiple designs and messages and even die cut shapes on the same string are options but increase cost.

What size? – Almost any size pennant/rectangle/die cut is available. Standard size is 12" x 18". Contact us for pricing for any other size.

Pennant Strings

Markets: Retail, Auto Dealerships, Restaurants, Shopping Malls

Uses: Events, Parades, Races, Parties, Picnics, Grand Openings, Advertising, Branding

Pennant Strings are an outstanding way to decorate outdoor venues. Make a statement at your next event!

Material: PVC
Usage: Outdoors / Indoors
Production time: 15 business days
Finish: Leads on each end
Made in USA: No
Prop 65 WARNING: Cancer and/or Reproductive Harm.
www.P65Warnings.ca.gov

Item	Length	Shape	12	25	50	100	250
PSPVC15T	15'	Triangle	175.00	96.50	56.20	31.90	22.00
PSPVC15R	15'	Rectangle	192.50	106.15	61.82	40.25	32.50
PSPVC30T	30'	Triangle	192.50	106.90	62.50	43.75	33.00
PSPVC30R	30'	Rectangle	211.75	117.58	82.50	66.65	53.30
PSPVC60T	60'	Triangle	210.00	126.00	90.00	73.75	56.65
PSPVC60R	60'	Rectangle	252.00	163.75	135.00	121.50	98.50
PSPVC100T	100'	Triangle	225.00	142.50	125.00	100.00	88.30
PSPVC100R	100'	Rectangle	292.50	230.00	218.50	173.30	159.15

Pricing is for one art file - please inquire for pricing if multiple files are needed.

Any Shape and Length Available



In-Stock 4 Mil Polyethylene Pennant Strings

Head to the races with the right look! Simply hang them across the finish line or doorway of your next event and start your engines!

Material: Polyethylene
Usage: Outdoors / Indoors
Production time: Stock item
Finish: Leads on each end
Made in USA: Yes
Prop 65 WARNING: Cancer and/or Reproductive Harm. www.P65Warnings.ca.gov



Multicolor				
Item	Length	1	26	
PS-30-A	30'	5.43	5.22	
PS-60-A	60'	10.33	9.89	
PS-100-A	100'	15.49	13.32	

U



Red, white and blue				
Item	Length	1	26	
PS-30-B	30'	5.43	5.22	
PS-60-B	60'	10.33	9.89	
PS-100-B	100'	15.59	13.32	

U



Black and white checkered				
Item	Length	2	25	50
CTS-30	30'	10.33	8.53	7.93
CTS-60	60'	16.30	15.76	15.43
CTS-100	100'	26.63	25.22	24.95

U



Display Products

**Wow them at your event and POP area
with high impact branding & messaging!**

When determining which Display Product best suits your client's needs...

Where will it be used? – Will it be displayed indoor or outdoor? Is floor space limited?

How will it be used/displayed? – How do you want your branding and messaging to look? Is it easy to set up and breakdown? Is it heavy? How often will graphics change?

How should messaging be presented? – Will there be 2-way traffic? Design your branding and messaging for optimal impact based upon the shape of the display.

What size? – Are there height restrictions? What are you promoting? How do you want to present your brand, product or message? Displays come in many sizes each with specific benefits presenting your image.

Backdrop Banners

Markets: Trade Shows, Retail, Schools, Sports, Businesses, Safety, Organizations, Financial, Healthcare

Uses: Branding, Advertising, Seminars, Conferences, Events

Add some high profile promotional display to any event or occasion with one of our backdrop banners.

Material: Premium Display Polyester

Usage: Indoors

Production time: 7-10 business days

Finish: Pole sleeve on top and bottom / 4 reinforced grommets on left and right side of banner

Made in USA: Yes

Prop 65 WARNING: Cancer and/or Reproductive Harm. www.P65Warnings.ca.gov



- **Easy Set Up**
- **Hardware Telescopes to a Maximum of 8' x 8' or 10' x 10'**
- **Includes Carrying Bag for Easy Transport**

Kits with banner and hardware							
Item	Product	Size	1	3	6	12	25
BBSS-200	Banner & Hardware	8' x 8'	500.00	415.00	375.00	340.00	325.00
BBW-2001T2K	Banner & Hardware	10' x 10'	725.00	625.00	585.00	525.00	495.00

Replacement banners and hardware							
Item	Product	Size	1	3	6	12	25
BBBS-200	Banner	8' x 8'	320.25	229.30	203.35	183.75	165.75
BBS-1	Hardware	Max. 8' x 8'	252.84	204.98	154.79	133.09	119.44
BBW-2001T2R	Banner	10' x 10'	552.00	401.20	371.40	256.95	226.00
BBW-2000T2	Hardware	Max. 10' x 10'	414.30	287.47	247.16	221.81	210.24



10' x 10' Banner & Hardware



8' x 8' Banner & Hardware



Hardware Only

*hardware imported

Pipe and Drape Backdrop Banners



An essential addition to any POP or trade show display. Designed to be hung from trade show pipes with S hooks (not included).

Material: Premium Display Polyester

Usage: Indoors

Production time: 10 business days

Finish: 9 reinforced grommets on top of banner

Made in USA: Yes



Item	Size	1	3	6	12	24
BBPD-B7	7.5' H x 8' W	278.75	223.00	178.25	143.25	121.75

Hardware and curtain not included

Window Static Clings



Outside Clings

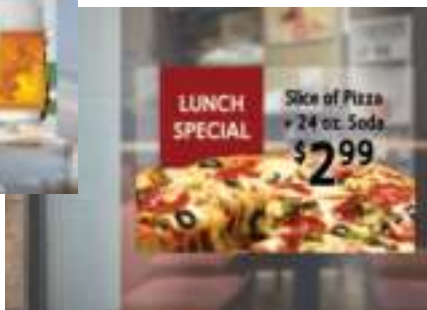

Inside Clings



Markets: Retail, Restaurants, Businesses, Schools, Financial, Auto Dealerships

Uses: Store Windows, School Bookstores

These reusable static clings are the perfect way to advertise without the use of tape or other forms of adhesive.

Material: PVC
 Usage: Outdoors / Indoors
 Production time: 7-10 business days
 Finish: Cut edges
 Made in USA: No
 Prop 65 WARNING: Cancer and/or Reproductive Harm.
www.P65Warnings.ca.gov

Outside						
Item	Size	100	250	500	1000	2500
WSC-560	5" x 6"	9.65	4.90	2.50	1.65	1.00
WSC-680	6" x 8"	10.50	5.45	3.00	1.70	1.25
WSC-8120	8" x 12"	11.80	5.95	3.55	2.35	1.65

R

Inside						
Item	Size	100	250	500	1000	2500
WSC-56I	5" x 6"	9.65	4.90	2.50	1.65	1.00
WSC-68I	6" x 8"	10.50	5.45	3.00	1.70	1.25
WSC-812I	8" x 12"	11.80	5.95	3.55	2.35	1.65

R

Stretch Door Runners

Markets: Retail, Schools, Sports Businesses, Safety, Organizations, Financial, Healthcare, Real Estate

Uses: Branding, Advertising, Seminars, Conferences, Decorating

Looking for a unique promotional item? We've got you covered with this stretch door runner!

Material: Stretch Polyester
 Usage: Indoors
 Production time: 7-10 business days
 Finish: Hemmed edges
 Made in USA: Yes



This runner slides perfectly on your door leaving enough room for the door knob.

Item	Size	1	3	6	12	25
SDR-24	24" for Doors up to 24" x 80"	141.55	127.50	111.30	97.05	83.00
SDR-30	30" for Doors up to 30" x 80"	158.25	145.00	129.85	115.45	98.65

R

Spring Walls

Markets: Trade Shows, Retail, Schools, Sports, Businesses, Safety, Organizations, Financial, Healthcare

Uses: Branding, Advertising, Seminars, Conferences, Events

Easy. Versatile. Lightweight. A must for anyone in need of a professional looking display that takes seconds to set up.

Material: Premium Display Polyester

Usage: Indoors

Production time: 7–10 business days

Finish: Sewn around the edges

Made in USA: Yes

Prop 65 WARNING: Cancer and/or Reproductive Harm. www.P65Warnings.ca.gov



Small kits - size 88.5" x 31" - carrying bag included						
Item	Product	1	3	6	12	25
POP-2001T1K	Banner & Hardware	736.16	569.83	499.42	460.59	429.77
POP-2001T1R	Replacement Banner	330.00	275.00	215.00	165.00	130.00

R

Medium kits - size 89.25" x 89.25" - carrying bag included						
Item	Product	1	3	6	12	25
POP-2001T2K	Banner & Hardware	870.50	644.88	564.71	523.83	489.15
POP-2001T2R	Replacement Banner	385.00	330.00	265.00	215.00	200.00

R

Collaboration Stations



Integrate technology into your trade show with this innovative and convenient product. This tablet stand is perfect for enhancing your brand and displaying the perfect message.

Material: Premium Polyester

Usage: Indoors

Production time: 7–10 business days

Finish: Zipper enclosure

Made in USA: No

Prop 65 WARNING: Cancer and/or Reproductive Harm. www.P65Warnings.ca.gov

Perfect for iPads or other tablets; the adjustable clamps allow you to easily display your gadget of choice. Accessories include: snap lock aluminum hardware, adjustable tablet clamp, anti-theft security lock, two screen gloves and black carry case.

Item	Size	1	3	6	12
TS-5015K	50" H x 15" 1/4 L x 22" W	484.85	342.40	299.50	276.00

R

*hardware imported

Retractable Banner Stands



This sleek and stylish banner stand is the best value retractable frame anywhere! Assemble without tools and features a satin silver finish.

Material: 200G Polyester
Usage: Indoors
Production time: 7-10 business days
Finish: Mounted to aluminum frame
Made in USA: No
Prop 65 WARNING: Cancer and/or Reproductive Harm.
www.P65Warnings.ca.gov

Item	Size	1	3	6	12
RBS-2463	24" x 63"	314.00	195.00	175.50	157.95
RBS-3236	32" x 36"	307.00	204.50	183.90	165.50
RBS-3248	32" x 48"	308.00	205.50	184.95	166.65
RBS-3260	32" x 60"	310.00	207.50	186.75	168.10
RBS-3279	32" x 79"	354.90	259.50	220.55	198.75

R



- **Lightweight**
- **Portable**
- **Instant Set-Up**
- **Easy Take Down**
- **Tool Free Assembly**

Easy A-Frames



Markets: Retail, Businesses, Sports, Shopping Malls, Healthcare, Schools

Uses: Event Messaging, Awareness, Direction, Advertising, Festivals

Use more than one to create a pathway, barrier or sideline. Note: the digitally printed sides can be printed with any image including two identical images, two different images, or background color on one side and your image on the other!

Material: Stretch Polyester
Usage: Outdoors / Indoors
Production time: 7-10 business days
Finish: Hemmed on bottom
Made in USA: No
Prop 65 WARNING: Cancer and/or Reproductive Harm.
www.P65Warnings.ca.gov



Accessories include 6 metal stakes and black carrying bag.

Item	Length	1	3	6	12	25
EADF-2001T2K	85" L x 24" W x 36" H	500.00	400.00	375.00	350.00	330.00

R

SlimFit Displays

Markets: Trade Shows, Retail, Schools, Sports, Businesses, Safety, Organizations, Financial, Healthcare

Uses: Branding, Advertising, Seminars, Conferences, Events

Sleek. Easy. Versatile. Lightweight. These aluminum tube-frame displays are a must for anyone in need of a professional looking backdrop that takes seconds to set up.

Material: Stretch Polyester / Display Polyester
 Usage: Indoors
 Production time: 7-10 business days
 Finish: Sewn around the edges
 Made in USA: Yes
 Prop 65 WARNING: Cancer and/or Reproductive Harm.
www.P65Warnings.ca.gov



- 2-Sided Graphic
- Lightweight Aluminum Frame
- Set Up Takes Minutes

SlimFit Wall

At 94.5" x 91" this SlimFit Display Wall offers a seamless-end presentation. Includes black carrying bag.

Item	Product	1	3	6	12	24
SLBW-2001T2K	Banner & Hardware	793.80	605.98	540.87	502.73	474.32
SLBW-2001T2R	Replacement Graphic	588.12	414.34	360.84	338.80	316.85



SlimFit Steel Base

The black steel base allows this 37.5" x 90" display with a small foot-print.

Item	Product	1	3	6	12	25
SLBSB-2001T2K	Banner & Hardware	435.00	405.00	365.00	340.00	315.00
SLBSB-2001T2KB	Banner, Hardware & Carry Bag	475.00	445.00	405.00	375.00	350.00
SLBSB-2001T2R	Replacement Graphic	240.00	228.00	205.00	183.75	165.00



SlimFit Ribbon

This 39" x 83" display offers a unique and edgy idea that can be used in all kinds of spaces. Includes black carrying bag.

Item	Product	1	3	6	12	24
SLRB-2001T2K	Banner & Hardware	796.00	506.97	426.97	356.85	329.72
SLRB-2001T2R	Replacement Graphic	436.37	257.43	205.67	168.92	149.21



Accessories



LED Clip Light
SLLA-5000T2



SlimFit Steel Base
Shelves
SLSA-5000T2

Visit
WWW.QUINNFLAGS.COM
for Accessories

*hardware imported

X-Banner Kits



Economy X-Banner Available!

Pack up and go with ease with all of the necessary hardware and a black carrying case for easy transportation. A simple solution for any event.

Material: Premium Display Polyester
Usage: Indoors
Production time: 7-10 business days
Finish: Hemmed edges / reinforced grommets in each corner
Made in USA: Yes
Prop 65 WARNING: Cancer and/or Reproductive Harm.
www.P65Warnings.ca.gov



Item	Size	Product	1	3	6	12	25
XBS-3174	30.5" x 74"	Banner & Hardware	185.50	150.00	113.95	94.20	86.65
XBR-3174	30.5" x 74"	Replacement Banner	135.50	100.00	72.30	52.60	44.25
XBS-2001T2K	24" x 60"	Banner & Hardware	165.00	132.00	99.00	79.20	73.25
XBS-2001T2R	24" x 60"	Replacement Banner	115.00	90.35	57.35	37.60	31.60
XBS-2002T2K	31" x 60"	Banner & Hardware	175.00	140.00	105.00	84.00	77.75
XBS-2002T2R	31" x 60"	Replacement Banner	125.00	81.75	63.35	42.35	36.10

R

Mini X-Banner Kits



Simple. Fast. Affordable. The Mini X-Banner is an ideal solution to include in any trade show or conference as a quick desktop or counter POP/Retail display.

Material: Premium Display Polyester
Usage: Indoors
Production time: 7-10 business days
Finish: Heat cut edges
Made in USA: No
Prop 65 WARNING: Cancer and/or Reproductive Harm.
www.P65Warnings.ca.gov

Item	Length	Product	6	12	25	50	100
MXBS-2001T1K	7.75" x 16.5"	Banner & Hardware	41.65	27.00	19.00	14.25	11.00
MXBS-2001T1R	7.75" x 16.5"	Replacement Banner	34.95	20.85	13.60	8.85	5.85

R

Tower Stands



Modern. Easy. Versatile. Lightweight. These Stretch Polyester Tower Stands are a fantastic addition to our products line.

Material: Stretch Polyester
Usage: Indoors
Production time: 7-10 business days
Finish: Hemmed edges
Made in USA: Yes
Prop 65 WARNING: Cancer and/or Reproductive Harm.
www.P65Warnings.ca.gov



Item	Product	1	3	6	12	25
TSFC-7	Full Curve Kit	493.49	351.14	326.58	286.38	275.78
TSPC-7	Pointed Curve Kit	493.49	351.14	326.58	286.38	275.78
TSFC-7R	Full Curve Replacement Banner	246.56	199.89	150.95	129.78	116.47
TSPC-7R	Pointed Curve Replacement Banner	246.56	199.89	150.95	129.78	116.47

R

*hardware imported

Backpack Flags



Markets: Trade Shows, Sports, Schools, Businesses, Political

Uses: Mobile Advertising, Festivals, Events, Branding

Create a truly mobile promo with a backpack flag. Perfect for use both indoors and out and assembles in minutes with no additional tools required. Backpack included!

Material: Polyester
Usage: Outdoors / Indoors
Production time: 7-10 business days
Finish: Black nylon pole sleeve
Made in USA: No
Prop 65 WARNING: Cancer and/or Reproductive Harm. www.P65Warnings.ca.gov

Single Reverse reads correct on one side and reversed on the backside.
 Double Sided reads correct on both sides and has a block-out liner in the center.

Single reverse							
Item	Flag Height	Shape	6	12	25	50	100
BPFST-1543H	43.25"	Half Drop	106.40	90.20	69.60	59.40	51.95
BPFST-2141T	41.25"	Teardrop	106.40	90.20	69.60	59.40	51.95

Double sided							
Item	Flag Height	Shape	6	12	25	50	100
BPFST-D1543H	43.25"	Half Drop	143.00	121.90	96.05	83.50	71.90
BPFST-D2141T	41.25"	Teardrop	143.00	121.90	96.05	83.50	71.90

Pop-Up Banners

Markets: Retail, Businesses, Sports, Shopping Malls, Healthcare, Schools

Uses: Event Messaging, Awareness, Direction, Advertising, Festivals

Reach for the sky during your next promotional campaign with these pop-up banners!

Material: Premium Display Polyester
Usage: Indoors / Temporary Outdoors
Production time: 7-10 business days
Finish: Sewn around the edges
Made in USA: No
Prop 65 WARNING: Cancer and/or Reproductive Harm. www.P65Warnings.ca.gov

- Highly Visible
- Cost Effective
- Portable
- Indoor & Outdoor Use
- Lightweight



Circle

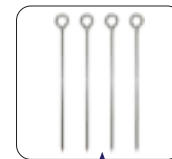

Includes ground spikes for use on soft surfaces



Triangle

Triangle						
Item	Size	1	3	6	12	25
POPT4747	47.25" x 47.25"	381.95	256.20	210.85	171.55	163.55
POPT5959	59" x 59"	454.65	317.15	265.00	223.50	202.10

Circle						
Item	Size	1	3	6	12	25
POPC39	39.37" x 39.37"	312.65	202.25	163.25	128.55	114.10
POPC47	47.25" x 47.25"	403.65	276.45	228.50	185.20	173.85
POPC59	59" x 59"	442.25	306.30	255.30	214.55	193.55

Vertical						
Item	Size	1	3	6	12	25
POPV2335	23.62" x 35.43"	309.90	196.10	157.85	128.55	114.10
POPV3966	39.37" x 66.9"	348.15	268.80	218.20	173.40	159.25
POPV4978	49.2" x 78.75"	457.75	322.80	268.80	226.95	206.75

Horizontal						
Item	Size	1	3	6	12	25
POP4727	47" x 27.55"	308.00	190.90	170.50	132.50	118.00
POP7939	78.75" x 39.4"	380.00	302.50	237.90	182.70	165.00
POP43102	43" x 102"	470.00	331.50	275.60	242.20	220.00



Vertical



Horizontal

InstaStands

- Quick Set Up
- Base Holds Up To 35 LBS
- Easy Set-Up & Take Down



InstaStands display themselves with pneumatic hardware!

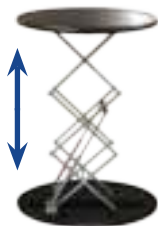

Markets: Trade Shows, Retail, Schools, Sports, Businesses, Safety, Organizations, Financial, Healthcare

Uses: Branding, Advertising, Seminars, Conferences, Events

Pack up and go with ease with all of the necessary hardware and a black carrying case for easy transportation. A simple solution for any pop-up meeting.

Material: Stretch Polyester

Usage: Indoors

Production time: 7-10 business days

Finish: Sewn around the edges

Made in USA: No

Prop 65 WARNING: Cancer and/or Reproductive Harm.

www.P65Warnings.ca.gov

Item	Product	1	3	6	12	25
ARTS-3001T2K	InstaStand Hardware & Banner	499.95	449.95	427.50	405.75	387.50
ARTS-3001T2R	InstaStand Replacement Graphic	210.00	169.45	152.50	137.25	130.75

R

Transformer Trunk Kits



Storage trunk compartment holds marketing materials, samples & much more!



Markets: Trade Shows, Retail, Schools, Sports, Businesses, Safety, Organizations, Financial, Healthcare

Uses: Branding, Advertising, Seminars, Storage

From traveling case to table stand in just a few easy steps, the Transformer Trunk is perfect for a single representative to set up. The possibilities for storage are endless!

Material: Stretch Polyester

Usage: Indoors

Production time: 7-10 business days

Finish: Hemmed edges

Made in USA: No

Prop 65 WARNING: Cancer and/or Reproductive Harm.

www.P65Warnings.ca.gov

Item	Product	1	3	6	12	25
TTTS-3001T2K	Banner & Hardware	715.00	640.00	585.00	555.00	530.00
TTTS-3001T2R	Replacement Graphic	170.00	127.40	113.90	89.75	71.75

R

Custom Display Tables



Add some professional flair with a portable and lightweight table that's built to deliver.

Material: Plastic / PVC

Usage: Indoors

Production time: 15 business days

Finish: Clouded PVC backing on top and bottom panels

Made in USA: No

Prop 65 WARNING: Cancer and/or Reproductive Harm.

www.P65Warnings.ca.gov

Item	Size	1	3	6	12	25
DTPOP-01	70" Tall	330.00	315.00	305.00	295.00	285.00

R

*hardware imported

Illuminator InstaStand Kits

Markets: Trade Shows, Retail, Schools, Sports, Businesses, Safety, Organizations, Financial, Healthcare

Uses: Branding, Advertising, Seminars, Conferences, Events

The lights on this InstaStand Table will make your graphic come to life! Set up in 3 seconds or less! The InstaStand Table Stand quickly goes from in case to set up without the need to remove the banner!

Material: GlowTec Fabric
Usage: Indoors
Production time: 7-10 business days
Finish: Hemmed edges
Made in USA: No
Prop 65 WARNING: Cancer and/or Reproductive Harm.
www.P65Warnings.ca.gov

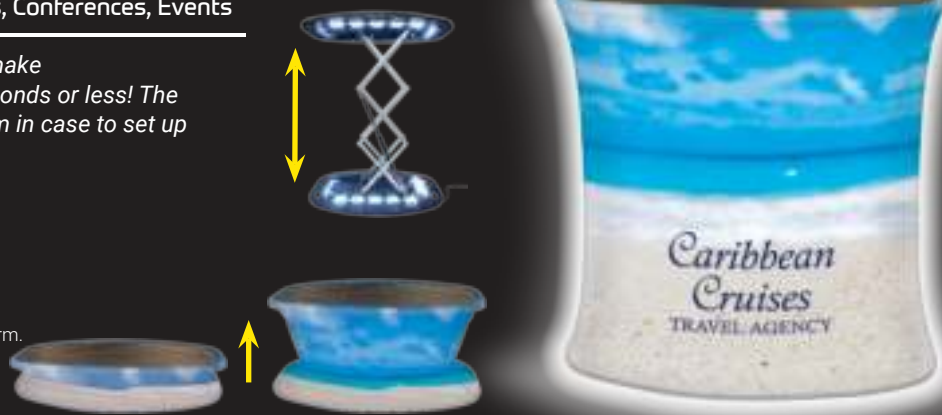

Item	Product	1	3	6	12
ARTS-3001T3K	Illuminator InstaStand Light Up Table Kit	660.65	627.65	596.25	566.50
ARTS-3001T3R	Illuminator InstaStand Graphic Replacement	266.40	229.00	204.85	173.35

Illuminator Display Kits

New and innovative way to get your brand noticed. The kit includes an aluminum frame, LED curtain light system and a full color attention-grabbing graphic.

Material: GlowTec Fabric
Usage: Indoors
Production time: 7-10 business days
Finish: Sewn around the edges
Made in USA: No
Prop 65 WARNING: Cancer and/or Reproductive Harm.
www.P65Warnings.ca.gov

L.E.D.



Item	Product	Size	1	3
SEGPOP-23K	5' Illuminator Kit	59.5" x 88.5"	1942.65	1520.10
SEGPOP-23R	GlowTec Fabric Replacement Graphic	59.5" x 88.5"	925.70	565.65
SEGPOP-33K	7' Illuminator Kit	88.5" x 88.5"	2215.90	1956.90
SEGPOP-33R	GlowTec Fabric Replacement Graphic	88.5" x 88.5"	1008.80	636.55

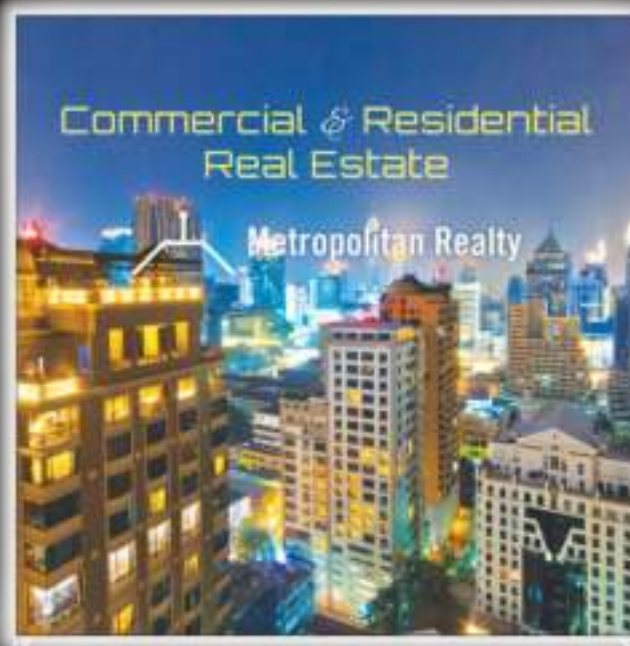

Trade Show Packages

Markets: Trade Shows, Schools, Sports, Businesses

Uses: Branding, Advertising, Seminars, Conferences

Your Trade Show Booth display design made easy. Are you looking for a one-stop-shop alternative to sifting through all the choices and combinations of products available? Let us do the work for you!

- Save Over 15%
- 4 Packages to Choose From



Material: Premium Polyester / Premium Display Polyester / Knit Polyester

Usage: Indoors

Production time: 7-10 business days

Finish: Sewn around the edges

Made in USA: Yes

Prop 65 WARNING: Cancer and/or Reproductive Harm.

www.P65Warnings.ca.gov



Starter Package

Item	1	3
TPZ-5001T1Z	876.40	832.50

R

Package Includes:

- Throw Style Table Cover for 6' Table (DTC-6F)
- X-Banner Kit (XBS-3174)
- 8' x 8' Backdrop Banner Kit (BBSS-200)

Trade Shows are crowded... Stand Out



Basic Package

Item	1	3
TPZ-5002T1Z	1123.90	1067.70

R

Package Includes:

- Throw Style Table Cover for 6' Table (DTC-6F)
- X-Banner Kit (XBS-3174)
- 8' x 8' Backdrop Banner Kit (BBSS-200)
- Portable Double Sided Teardrop with Hardware and Cross Base (PTB-D8KC)

*hardware imported

Your trade show display design made easy



Sleek Package

Item	1	3
TPZ-5003T1Z	1665.25	1557.20

Package Includes:

- Stretch Style Table Cover for 6' Table (DTCS-6)
- SlimFit Steel Base Kit (SLBSB-2001T2K)
- SlimFit Wall Kit (SLBW-2001T2K)
- InstaStand (ARTS-3001T2K)



Superior Package

Item	1	3
TPZ-5004T1Z	1900.00	1750.00

Package Includes:

- Stretch Style Table Cover for 6' Table (DTCS-6)
- SlimFit Steel Base Kit (SLBSB-2001T2K)
- SlimFit Wall Kit (SLBW-2001T2K)
- InstaStand (ARTS-3001T2K)
- X-Banner Kit (XBS-3174)
- Mini X-Banner Kit (MXBS-2001T1K)

All packages include: Display hardware system, applicable banners/flags shown and accessories included with each individual product. Table not included. Due to the differences in fabric materials, packages may include products with slight color variations.

*hardware imported

Booth in a Box

Markets: Trade Shows, Schools, Businesses

Uses: Branding, Advertising, Seminars, Conferences

*Introducing your entire Trade Show Booth... In A Box!
One person can easily transport their entire booth display because all hardware and graphics fit INSIDE one wheeled display.*

Material: Premium Display Polyester, Premium Polyester, Premium Satin, Stretch Polyester, Knit Polyester

Usage: Indoors

Production time: 7-10 business days

Finish: Sewn around the edges, Mini X-Banner features heat-cut edges

Made in USA: Yes

Prop 65 WARNING: Cancer and/or Reproductive Harm.
www.P65Warnings.ca.gov



All hardware and graphics can be stored and transported



INSIDE

one display with wheels!



Booth in a Box Package A

Item	1
BIB-A	1666.66

R

Package Includes:

- Transformer Trunk (TTTS-3001T2K)
- Medium Spring Wall (POP-2001T2K)
- X-Banner (XBS-3174)
- 6' Stretch Table Cover (DTC-6)
- 2 Mini X-Banner Kits (MXBS-2001T1K)



Booth in a Box Package B

Item	1
BIB-B	1710.00

R

Package Includes:

- Transformer Trunk (TTTS-3001T2K)
- Tower Stand w/Pointed Curve (TSPC-7)
- 6' Portable Teardrop Banner w/Cross Base (PTB-6KC)
- 2 Mini X-Banner Kits (MXBS-2001T1K)
- 6' Throw Table Cover (DTC-6F)
- 7'x8' Pipe & Drape Backdrop Banner (BBPD-87)

*hardware imported

One easy-to-transport package that fulfills your trade show needs



Booth in a Box Package C

Item	1
BIB-C	1800.00
	R

Package Includes:

- Transformer Trunk (TTTS-3001T2K)
- X-Banner Kit (XBS-3174)
- 2 Mini X-Banner Kits (MXBS-2001T1K)
- 6' Portable Teardrop Banner w/ Cross Base (PTB-6KC)
- 6' Stretch Table Cover (DTCS-6)
- SlimFit Wall w/2 LED Clip Lights (SLBW-2001T2K / SLLA-5000T2)



Booth in a Box Package D

Item	1
BIB-D	2150.00
	R

Package Includes:

- Transformer Trunk (TTTS-3001T2K)
- Tower Stand w/Pointed Curve (TSPC-7)
- 6' Throw Table Cover (DTC-6F)
- Collaboration Station (TS-5015K)
- 2 Mini X-Banner Kits (MXBS-2001T1K)
- 39.37" Circle Pop-Up Banner (POPC39)
- 7'x8' Pipe & Drape Backdrop Banner (BBPD-87)



Trunk features a handle and integrated wheels for easy transport



Heavy duty straps hold trunk (and packaged displays) in one display



Most displays include their own bag

Due to the differences in fabric materials, packages may include products with slight color variations.

*hardware imported



American Flags and Stock Products

Show your Patriotism everywhere and anywhere!

When determining which American Flag & Stock Product best suits your client's needs...

Where will it be used? – We provide different materials for indoor or outdoor use. Choosing the right material for the correct use for your client's needs shows that you are the expert!

How will it be used/displayed? – Flags can be displayed many ways; off a building, on a flag pole, on a wall, etc... we have stock hardware options that can best meet your client's needs.

How should messaging be presented? – There are options for messaging on the heading of flags, imprinted staffs and customized packaging!

What size? – Displaying the American flag with other flags includes specific etiquette rules that should be followed. If displayed on separate hardware, the flags should all be the same size except the American flag should always be to the left of the viewer. If multiple flags are displayed vertically, the American flag should be 1 size larger than the other flags.

Patriotic American Flag Products

Economy Cotton U.S. Stick Flags



**Please Inquire for Imprint
on Wooden Staffs
Up to 40 Characters of Text**

Markets: Organizations, Businesses, Political, Sports
Uses: Parades, Patriotic, Giveaways, Decoration

Wave a traditional promotion at your next event with a cotton U.S. stick flag on a dowel!

Material: Cotton
Usage: Outdoors
Production time: Stock item
Finish: Mounted to a wooden dowel
Made in USA: Yes



Item	Flag size	Staff size	12	144	1440	5000
EC-46	4" x 6"	10"	0.52	0.36	0.32	0.30
EC-69	6" x 9"	18"	0.88	0.76	0.68	0.64
EC-812	8" x 12"	24"	1.20	1.04	0.92	0.84
EC-1218	12" x 18"	30"	1.80	1.60	1.48	1.32

Heavy Duty Pleated Fans



Markets: Organizations, Businesses, Political, Sports
Uses: Patriotic, Decoration

Create the right promotional display for any event with these striped pleated fans.

Material: Polyester
Usage: Outdoors
Production time: Stock item
Finish: Sewn around the edges
Made in USA: No
Prop 65 WARNING: Cancer and/or Reproductive Harm.
www.P65Warnings.ca.gov

Our most popular and most durable Pleated Fans feature appliquéd sewn stars and stripes. Made of durable, heavyweight polyester material and finished with canvas heading and grommets.

Heavy duty pleated fans					
Item	Size	Material	1	12	25
PFF-527	27" x 54"	Heavyweight Polyester	18.50	17.90	16.90
PFF-536	3' x 6'	Heavyweight Polyester	37.50	35.00	33.25
PFF-548	4' x 8'	Heavyweight Polyester	34.50	32.50	29.50
PFF-551	5' x 10'	Heavyweight Polyester	39.50	36.50	35.00

Cotton Pleated Fans



Material: Cotton
Usage: Outdoors
Production time: Stock item
Finish: Sewn around the edges
Made in USA: No
Prop 65 WARNING: Cancer and/or Reproductive Harm.
www.P65Warnings.ca.gov

Constructed out of cotton, these printed Pleated Fans feature 5 stripes with stars. Excellent for short term use.

Cotton pleated fans				
Item	Size	Material	1	6
PFF-501	18" x 36"	Printed Cotton	14.95	13.50
PFF-502	3' x 6'	Printed Cotton	22.95	20.75
PFF-503	4' x 8'	Printed Cotton	53.00	50.00

U.S. Nylon Flags



Markets: Used In All Markets

Uses: Patriotic, Flagpole Display, Building Display

Display some stars and stripes during your next marketing campaign with our outdoor nylon flags.

Material: Nylon
Usage: Outdoors
Production time: Stock item
Finish: Sewn around the edges
Made in USA: Yes



Our popular nylon American Flags are versatile and long lasting. Constructed from a durable 200 denier Dupont™ nylon, each flag features sewn stripes, embroidered stars and is fully hemmed with additional reinforced stitching on the fly end for support and longevity.

Item	Size	Finishing	1	12	25	50
NF-120	2' x 3'	Heading & Grommets	19.00	17.64	16.72	15.92
NF-135	3' x 5'	Heading & Grommets	32.24	29.96	28.68	27.56
NF-145	4' x 6'	Heading & Grommets	35.84	33.28	31.92	30.64
NF-150	5' x 8'	Heading & Grommets	50.32	46.72	44.80	43.00
NF-155	5' x 9.5'	Heading & Grommets	59.08	55.80	53.56	51.48
NF-160	6' x 10'	Heading & Grommets	83.48	78.84	75.64	72.76

Item	Size	Finishing	1	3	6	12
NF-165	8' x 12'	Rope & Thimble	186.68	176.28	169.24	162.76
NF-170	10' x 15'	Rope & Thimble	241.60	228.16	219.00	210.60
NF-175	10' x 19'	Rope & Thimble	292.08	275.88	264.80	254.64
NF-180	12' x 18'	Rope & Thimble	362.40	342.24	328.56	315.92
NF-185	15' x 25'	Rope & Thimble	575.40	543.40	521.68	501.60

2-Ply Polyester Flags



Show your American pride during the holidays, paying tribute to the Armed Forces or simply putting your patriotism on display.

Material: Polyester
Usage: Outdoors
Production time: Stock item
Finish: Sewn around the edges
Made in USA: Yes

Our 2-ply polyester American Flags are long lasting and great for windy outdoor conditions. Constructed from a durable 2-ply woven polyester, each flag features sewn stripes, embroidered stars and is fully hemmed with additional reinforced stitching on the fly end for support and longevity.

Item	Size	Finishing	1	12	25	50
PF-105	3' x 5'	Heading & Grommets	41.36	38.40	36.80	36.72
PF-110	4' x 6'	Heading & Grommets	47.32	43.96	42.12	40.48
PF-115	5' x 8'	Heading & Grommets	75.48	70.08	67.20	64.56
PF-120	5' x 9.5'	Heading & Grommets	92.48	87.32	83.84	80.60
PF-125	6' x 10'	Heading & Grommets	112.88	106.60	102.36	98.40

Item	Size	Finishing	1	3	6	12
PF-130	8' x 12'	Rope & Thimble	202.04	190.80	183.20	176.16
PF-135	10' x 15'	Rope & Thimble	307.44	290.40	278.76	268.00
PF-140	10' x 19'	Rope & Thimble	347.00	327.72	314.60	302.52
PF-145	12' x 18'	Rope & Thimble	428.24	404.44	388.28	373.36
PF-150	15' x 25'	Rope & Thimble	636.88	601.48	577.44	555.24

U.S. Promotional Printed Poly / Cotton Flags and Home Sets



Markets: Businesses, Residential, Organizations

Uses: Giveaways, Patriotic, Building Display

Durable yet inexpensive, these outdoors flags are made of a durable printed polyester/cotton material with 2-needle stitching and sturdy heading and grommets.

Material: Polyester / Cotton

Usage: Outdoors

Production time: Stock item

Finish: Sewn around the edges

Made in USA: Yes

Prop 65 WARNING: Cancer and/or Reproductive Harm. www.P65Warnings.ca.gov

Item	Size	1	12	48	144
PCF-35	3' x 5' American Flag **	12.00	10.80	9.60	9.20
Item	Size	24	48	96	240
US-198	6' Flagpole with 3' x 5' Flag	28.00	26.40	25.20	24.40

*hardware imported
**shipped bulk package

Message Flags and Flagpoles



Markets: Businesses, Real Estate, Construction, Restaurants

Uses: Messaging, Flagpole Display

Create something that's perfect for any store front with these 3' x 5' message flags. Designed with a red top border and a blue bottom border with the size and look that will attract business!

Material: Polyester

Usage: Outdoors

Production time: 7-10 business days

Finish: Sewn around the edges

Made in USA: Yes

Prop 65 WARNING: Cancer and/or Reproductive Harm. www.P65Warnings.ca.gov



Item	Size	Material	1	12
A-6105	3' x 5'	Open Flag	23.95	22.50
A-6100	3' x 5'	Welcome Flag	23.95	22.50
ADP-800CS	8'	Outdoor Display Flagpole*	23.96	22.80
MSO-899	8'	8' Indoor Telescopic Flagpole*	44.90	39.50

*hardware imported

Aluminum Flagpoles

Comes with a 2" diameter pole, die-cast aluminum cleats, durable halyard rope, 3/8" nylon snap hooks, 2" cast aluminum truck with nylon pulley, PVC ground sleeve and 3" gold anodized aluminum ball.

Item	Size	Color	Flag included	Style	1
AFP-16	16'	Silver	No	Sectional	109.50
AFP-20	20'	Silver	No	Sectional	94.50
AFP-20-WHITE	20'	White	No	Sectional	99.95
AFP-25F	25'	Silver	Yes	Sectional	139.90

Our "top of the line" and most durable aluminum flagpole features a spring release button to extend or retract the pole in seconds. Measuring at 20' at its maximum length and 70" when collapsed makes it ideal for a wide variety of occasions. Includes ground sleeve. Flag not included.

Item	Size	Color	Flag included	Style	1
RTF-120	20'	Satin Finish	No	Telescoping	99.50

Prop 65 WARNING: Cancer and/or Reproductive Harm. www.P65Warnings.ca.gov



Historical and Military Flags



Markets: Businesses, Organizations, Municipal, Financial

Uses: Flagpole Display, Indoor Display, Patriotic

Material: Polyester / Nylon
 Usage: Outdoors
 Production time: 3-5 business days
 Finish: Sewn around the edges
 Made in USA: Yes



Many styles and sizes available. See website for prices or contact us.

State and International Flags



Markets: Historic Associations, Patriotic

Uses: Holiday Parades, Museums, Patriotic Events

Material: Polyester / Nylon
 Usage: Outdoors
 Production time: 3-5 business days
 Finish: Sewn around the edges
 Made in USA: Yes



Indoor Sets and Hardware

Soar high above the competition with our oak pole indoor mounting set with a spear or Eagle top!

Material: Plastic / Wood / Brass
 Usage: Indoors
 Production time: 3-5 business days
 Made in USA: No
 Prop 65 WARNING: Cancer and/or Reproductive Harm.
www.P65Warnings.ca.gov



Indoor display set with eagle topper		
Item	Size	1
MSO-497	7' x 1 1/4"	138.00
MSO-550	8' x 1 1/4"	162.80
MSO-560	9' x 1 1/4"	166.80

Indoor display set with spear topper		
Item	Size	1
MSO-498	7' x 1 1/4"	138.00
MSO-499	8' x 1 1/4"	152.00
MSO-561	9' x 1 1/4"	157.60

Staff Mounted State Rayon Flags

Celebrate the feeling of unity with this stand-out set of 50 4" x 6" staff mounted state flags!

Material: Rayon
 Usage: Indoors
 Production time: 5-7 business days
 Made in USA: Yes
 Prop 65 WARNING: Cancer and/or Reproductive Harm.
www.P65Warnings.ca.gov



State rayon flag sets		
Item	Size	1
CSS-46	4' x 6"	100.96

All Made in the U.S.A!



Half Drop Banners

Swooper Banners



Teardrop Banners



Golf Flags

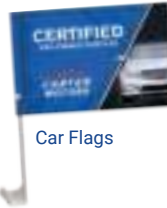

Car Flags



Knit Polyester Flags

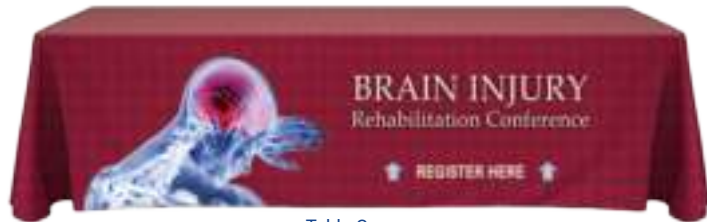

Table Covers

24-Hour Quick Ship

Single Reverse reads correct on one side and reversed on the backside.

Golf flags (single reverse)						
Item	Size	Finish	1	3	6	12
GFGS-142024	14" x 20"	Heading & Grommets	206.00	96.50	53.00	30.50
GFTS-142024	14" x 20"	Sewn in Golf Tube*	209.00	99.50	63.00	38.00

Half drop banner kits*				
Item	Size	Sides	1	3
PHB-6K24	6'	Single Reverse	302.95	215.10
PHB-8K24	8'	Single Reverse	317.95	233.80

Teardrop banner kits*				
Item	Size	Sides	1	3
PTB-6K24	6'	Single Reverse	302.95	215.10
PTB-8K24	8'	Single Reverse	317.95	233.80

Swooper banner kits*			
Item	Size	Sides	1
SWOOP-C12K24	12'	Single Reverse	259.55

Knit polyester flags (single reverse)				
Item	Size	1	3	6
DPP-2324	2' x 3'	225.00	115.00	70.70
DPP-3524	3' x 5'	250.00	141.00	95.50

Car flags* (single reverse)				
Item	Size	6	12	25
CCFP-75S24	7.5" x 10.5"	45.20	30.50	20.30
CCFP-115S24	11.5" x 15"	59.20	40.95	31.70

Table covers			
Item	Size	Style	1
DTC-6F24	6'	Throw Style	380.00
DTC-8F24	8'	Throw Style	400.00

48-Hour Quick Ship

Golf flags (single reverse)						
Item	Size	Finish	1	3	6	12
GFGS-142048	14" x 20"	Heading & Grommets	164.20	82.70	45.80	26.85
GFTS-142048	14" x 20"	Sewn in Golf Tube*	166.50	85.20	55.80	34.35

Half drop banner kits*				
Item	Size	Sides	1	3
PHB-6K48	6'	Single Reverse	261.30	206.80
PHB-8K48	8'	Single Reverse	279.60	224.80

Teardrop banner kits*				
Item	Size	Sides	1	3
PTB-6K48	6'	Single Reverse	261.30	206.80
PTB-8K48	8'	Single Reverse	279.60	224.80

Swooper banner kits*			
Item	Size	Sides	1
SWOOP-C1248	12'	Single Reverse	217.90

Knit polyester flags (single reverse)				
Item	Size	1	3	6
DPP-2348	2' x 3'	183.20	100.90	63.75
DPP-3548	3' x 5'	207.70	127.70	91.40

Car flags* (single reverse)				
Item	Size	6	12	25
CCFP-75S48	7.5" x 10.5"	38.25	26.95	19.55
CCFP-115S48	11.5" x 15"	52.25	39.40	30.50

Table covers			
Item	Size	Style	1
DTC-6F48	6'	Throw Style	338.35
DTC-8F48	8'	Throw Style	358.35



QUICK SHIP GUIDELINES

- Proofs not available.
- Order must ship via UPS only.
- Product time guarantee while capacity is available.
- Quick turn items cannot be combined with regular lead time items on purchase order.
- Complete purchase order, and artwork on QUINN template, must be received by 3:00 p.m. EST.
- Factory will not be held responsible for any delays in the shipment due to discrepancies with the artwork and/or items on purchase order.
- Additional Quick Ship products are available. Visit www.quinnflags.com for the most up-to-date available Quick Ship products.

*Prop 65 WARNING: Cancer and/or Reproductive Harm. www.P65Warnings.ca.gov

*hardware imported

QUINN

BEST SELLERS



OUTDOOR AND
LIGHTWEIGHT FLAGS



PORTABLE BANNERS



TABLE COVERS



PENNANT STRINGS



STICK FLAGS



X-BANNERS AND
RETRACTABLE BANNERS



FELT PENNANTS



CAR FLAGS



TENTS



Follow us on

